

ANT-20SE
Advanced Network Tester

Broadband Analyzer/Generator

BN 3060/90.51

Software Version 7.20

Operating Manual

Please direct all enquiries to your local Wavetek Wandel Goltermann sales company. The addresses are given at the end of this handbook.

Copyrights

This product or parts of it are based upon Recommendations and/or Standards of the Standardization Sector of the International Telecommunication Union - ITU-T and/or of the European Telecommunications Standards Institute - ETSI. These Recommendations and Standards are subject to copyrights of these organizations. Without written permission of the ITU-T and/or ETSI it is not permitted to copy ITU-T Recommendations or ETSI standards or parts thereof and/or make them available to third parties.

Wavetek Wandel Goltermann
Eningen GmbH & Co.
Mühleweg 5, 72800 Eningen u. A.
© 2000

Author: MDD/TD
Translator: John Nutley

Order no.: BN 3060/98.32
Edition: 02/00.07 (V 7.20)

Previous edition:
01/00.04 (V 7.1)

Subject to change without notice
Our normal guarantee and delivery
terms apply

Printed in Germany



Contents

Introduction

1	Main applications of the Broadband Analyzer/Generator	..I-1
2	Application concept	..I-2
3	Test applications	..I-5
3.1	ATM performance analysis	..I-5
3.2	Traffic management tests	..I-5
3.3	UNI signaling tests	..I-6
3.4	Analysis of ATM signals	..I-6
3.5	Other fields of application	..I-6
4	Using and setting up the Broadband Analyzer/Generator	..I-7
5	Overview: Virtual Instruments, “VIs”	..I-8
6	Often used terminology	..I-9

Operation

1	ATM Test Control	..O-1
1.1	Introduction	..O-1
1.2	“ATM Test Control” window layout and commands	..O-2
1.3	Important dialog windows	..O-4
2	ATM Test Results	..O-7
2.1	Introduction	..O-7
2.2	“ATM Test Results” main window layout and commands	..O-7
2.3	Results window	..O-9
3	ATM Channel Explorer	..O-11
3.1	Introduction	..O-11
3.2	“ATM Channel Explorer” window layout and commands	..O-12
3.3	Results window	..O-14



- 4 Port configurations (topologies) and Instrument Configuration O-16**
 - 4.1 Overview O-16
 - 4.2 The “Instrument Configuration” dialog O-16
 - 4.3 Port configuration O-17
 - 4.4 Tx/Rx Configuration O-19
 - 4.4.1 The “ATM Layer” dialog O-19
 - 4.4.2 “Edit Signal Structure” O-21
 - 4.5 Signaling emulation. O-21
 - 4.5.1 The “Signaling Protocol” dialog. O-21
 - 4.5.2 The “Address Input” dialog O-22

- 5 Test Types O-25**
 - 5.1 Overview O-25
 - 5.2 The “Test Setup” dialog: Setting the Test Type O-26
 - 5.3 The “ATM Layer QoS - Looped Topology” test type O-27
 - 5.4 The “ATM Layer QoS (PVC) - Point-to-point” test type. O-28
 - 5.5 The “ATM Layer QoS (PVC) - Looped” test type O-29
 - 5.6 The “ATM Layer QoS (SVC) - Calling” test type O-30
 - 5.7 The “ATM Layer QoS (SVC) - Called” test type O-30
 - 5.8 The “ATM Layer QoS (SVC) - Self Call” test type. O-31
 - 5.9 The “Test Setup <...>” dialog: Configure test type O-32
 - 5.9.1 Select channel O-33
 - 5.9.2 Header O-34
 - 5.9.3 Called party address. O-35
 - 5.9.4 Own instrument address. O-35
 - 5.9.5 Source parameters O-36
 - 5.9.6 Multiplexer. O-37
 - 5.9.7 Channel labeling O-37

- 6 Defining Virtual Channels O-38**
 - 6.1 Overview O-38
 - 6.2 The “Channel Editor” dialog O-38
 - 6.3 Parameter display and modification (index cards) O-40
 - 6.3.1 The “General” index card O-40
 - 6.3.2 The “Header/Address” index card. O-41
 - 6.3.3 The “Traffic Contract” index card O-43
 - 6.3.4 The “Traffic Contract” index card (continued) O-44
 - 6.3.5 The “Traffic Source” index card O-45



Application Guide

1	The Application Manager	A-1
1.1	Selecting the Instruments for ATM Applications	A-1
1.2	Starting and Stopping the Measurement.	A-2
2	ATM Layer Quality of Service Measurements (SVC)	A-3
2.1	Overview: Basic operating sequence	A-3
2.2	Test setup and description	A-4
2.3	Application settings	A-4
2.3.1	Configuring the Instrument: “ATM Test Control” VI.	A-5
2.3.2	Selecting the Test Type: “ATM Test Control” VI	A-9
2.3.3	Configuring the Test Type: “ATM Test Control” VI	A-10
2.4	Enabling and Disabling Test Traffic: “ATM Test Control” VI	A-12
2.5	Editing Test Parameters “On-Line”: “ATM Test Control” VI	A-13
2.6	Inserting Errors: “ATM Test Control” VI.	A-14
2.7	Displaying the Results: “ATM Test Results” VI	A-15
2.7.1	Preparing to Record Results	A-15
2.7.2	Displaying the Signaling Analysis	A-16
2.7.3	The “Quality Of Service” window.	A-18
2.7.4	The “Receiver Status” window	A-20
3	Detecting and analyzing ATM channels (Channel Explorer)	A-22
3.1	Overview: Basic operating sequence	A-22
3.2	Test setup and description	A-23
3.3	Application settings	A-23
3.4	Measurement	A-24
3.4.1	“Activity” Scan: Detect and Display Active ATM Channels.	A-24
3.4.2	Analyzing the AAL types of active ATM channels.	A-25
3.4.3	Displaying the AAL Type Distribution	A-26
3.4.4	Trouble Scan: Detecting and displaying ATM Channels where alarms are present.	A-27
3.5	Selecting Options	A-29
3.6	Sorting Channels.	A-30



Technical Background

1	ATM Traffic Generation and Multiplexing	TB-1
1.1	Overview	TB-1
1.2	Generator Principle	TB-2
1.3	Source Models	TB-2
1.3.1	“Constant Bit Rate” source model	TB-3
1.3.2	“On-Off” source model	TB-4
1.4	Traffic Control and Multiplexing Method	TB-5
1.5	Traffic Shaper	TB-8
2	Testing Switched Virtual Circuits (SVCs)	TB-9
2.1	General features of the signaling (Software version 6.5)	TB-9
2.2	Interoperability with other instruments	TB-9
2.3	Starting and stopping signaling, generating test traffic	TB-10
2.4	“Calling” mode	TB-10
2.5	“Called” mode	TB-13
2.6	“Self Call” mode	TB-15

Specifications “ATM Layer”

1	Generator	S-1
1.1	Scrambling	S-1
1.2	Fill Cells	S-1
1.3	Cell Header	S-1
1.4	General Functions	S-2
1.4.1	Error Insertion (Anomalies)	S-2
1.4.2	Alarm Generation (Defects)	S-2
1.5	Functions for ATM Layer Quality of Service Measurements	S-3
1.5.1	General	S-3
1.5.2	Error Insertion (Anomalies)	S-3
1.5.3	Alarm Generation	S-3
1.5.4	Test Cell Format	S-3



1.6	Source Models	S-4
1.6.1	Constant Bit Rate Model	S-4
1.6.2	“On-Off” Model	S-4
1.7	Traffic Shaper	S-5
1.7.1	Traffic Shaper for CBR, UBR and DBR Traffic Contracts . . .	S-5
1.7.2	Traffic Shaper for VBR and SBR Traffic Contracts	S-6
2	Receiver	S-7
2.1	Descrambling	S-7
2.2	General Functions	S-7
2.2.1	Error Measurements (Anomalies)	S-7
2.2.2	Alarm Detection (Defects)	S-7
2.2.3	Receiver Bandwidth	S-7
2.3	ATM Layer Quality of Service Measurements	S-8
2.3.1	General Features	S-8
2.3.2	Error Related Parameters	S-8
2.3.3	Delay Related Parameters	S-8
2.3.4	Alarm Detection (Defects)	S-9
2.3.5	Other Parameters	S-9
2.4	Channel Explorer	S-10
2.4.1	Activity Scan	S-10
2.4.2	Trouble Scan	S-10
2.4.3	AAL analysis	S-11
3	Signaling	S-12
3.1	Traffic Contracts	S-12
3.2	Signaling Analysis	S-12
4	Note for ANT-20SE users	S-13

Index



Notes:



Introduction

1 Main applications of the Broadband Analyzer/Generator

ATM is set to change the landscape in WANs and LANs in the coming years. Practically all network operators view ATM as a key technology in enabling them to provide the required high quality standard in future services.

With the Broadband Analyzer/Generator the right tool is provided to you for performing ATM tests in a simply, reliably manner and with highest accuracy.

The tester is particularly suitable for

- commissioning,
- acceptance testing and
- in-service testing of ATM services, switches and networks.

This means that your network management is enhanced to provide performance tests that guarantee the best possible "Quality of Service". A special feature, the real-time function supports the test, which also allows you to optimize the ATM traffic management.

Both SVCs (Switched Virtual Circuits) and PVCs (Permanent Virtual Circuits) are tested precisely.

Testing of different ATM service categories will be supported directly by the Broadband Analyzer/Generator.

ATM traffic contracts can be analyzed in detail and can therefore be guaranteed by means of an acceptance test. The figure below shows the relationship between the ATM Forum and ITU-T service categories, their traffic descriptions and the minimum guarantee corresponding to the appropriate traffic contract.

Service Category	Traffic Description	Guarantees Quality of Service
CBR DBR	PCR and $CDVT_{PCR}$	Bandwidth, min CLR max CTD, $CDV_{peak-to-peak}$
nrt-VBR	PCR, SCR, MBS $CDVT_{BCR}$ and $CDVT_{PCR}$	Bandwidth, min CLR max CTD, $CDV_{peak-to-peak}$
CBR	PCR, SCR, MBS $CDVT_{BCR}$ and $CDVT_{PCR}$	Bandwidth, min CLR
ABR	PCR, MCR and $CDVT_{PCR}$	Bandwidth, low CLR for conforming sources
UBR	PCR, MCR and $CDVT_{PCR}$	No

Fig. I-1 Features of ITU-T and ATM Forum traffic contracts

All the test applications have been developed in accordance with the latest information from the standardization bodies ATM Forum and ITU-T to ensure that they are always up to date.

Your Wavetek Wandel Goltermann Sales Partner can supply the latest information about software upgrades and new options to keep you abreast of the latest developments in ATM test technology.

2 Application concept

The Broadband Analyzer/Generator in the ANT-20SE is an ATM tester that is equipped with integrated interfaces. This ensures that the necessary interface is easily accessible when you are on the move.

Range of interface types used in ATM

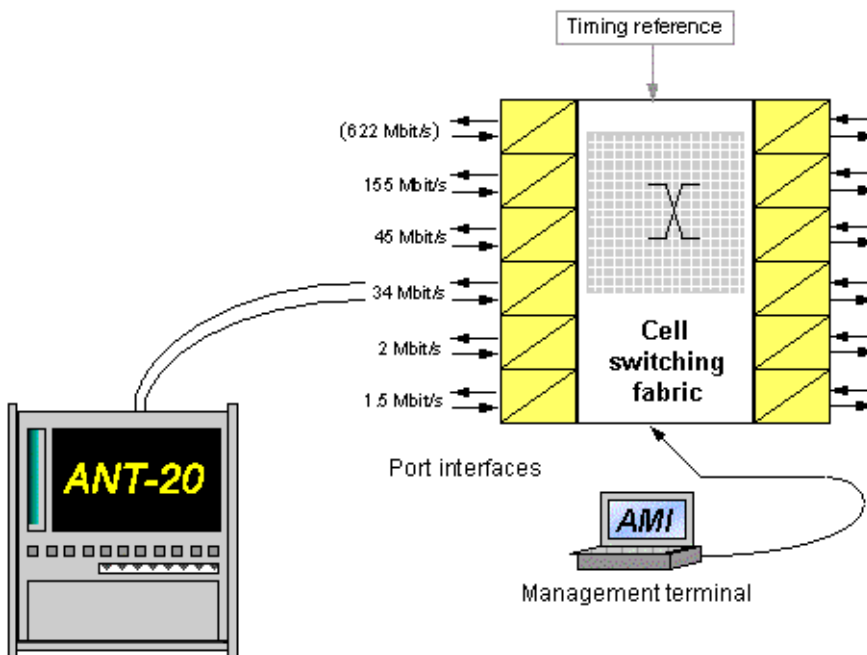

Fig. I-2 Comprehensive choice of interfaces for the ANT-20SE

The Broadband Analyzer/Generator operates in “Emulate” mode for an UNI interface for most test applications. This configuration provides the test instrument with characteristics that are similar to those of an ATM terminal. This configuration also allows signaling emulation to enable you to make performance measurements using ATM switched virtual circuits. The function is also used for testing the major characteristics of ATM switches.

ATM tests on SVCs can be performed faster and more effectively since you no longer need to be concerned with setting up and clearing down the connection.



The diagram below illustrates the steps that the Broadband Analyzer/Generator performs automatically, when a self-call was initiated:

1. Test circuit set up
2. Performance analysis over the test circuit

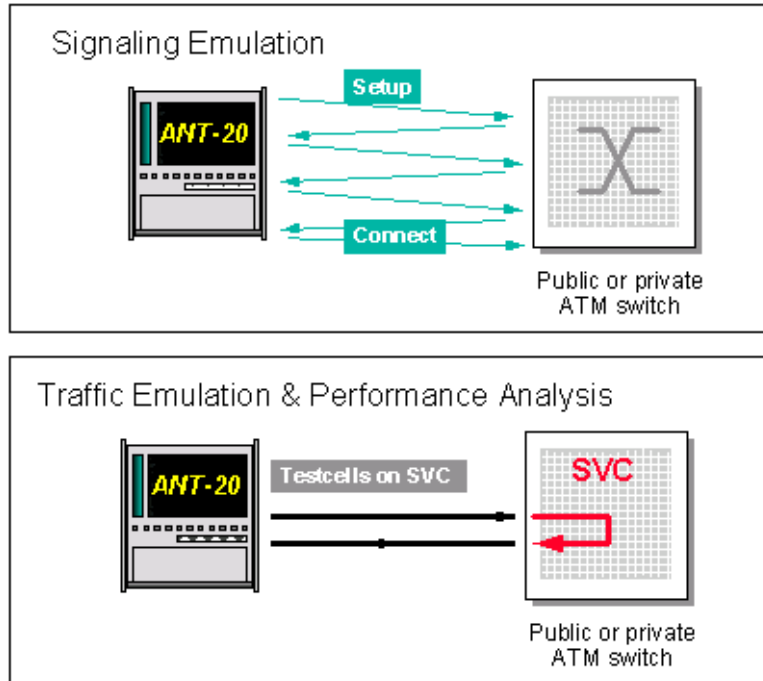

Fig. I-3 Automatic test sequence for switched virtual circuits

The receiver of the Broadband Analyzer/Generator can be used separately for troubleshooting or analysis. The ANT-20SE can be used with a “T” connector or optical power splitter for this monitor type operating mode.

In-service monitoring and measurements

- Passive with power splitter or test cable
- Active with instrument looped-in (through mode)

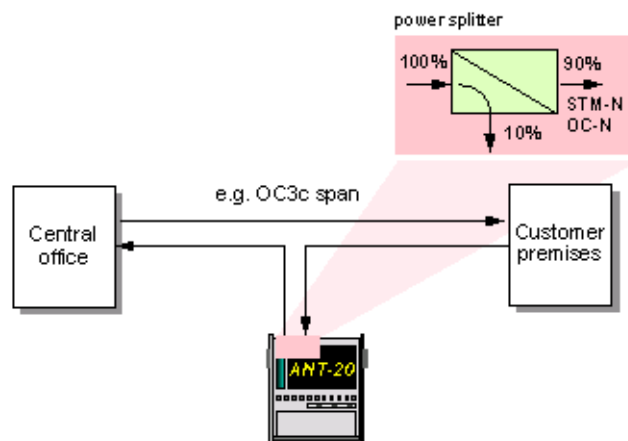

Fig. I-4 ANT-20SE monitor function

All test applications are supported by a practical application and channel database. In the simplest scenario, an application is called up and started directly.

With the ATM channel editor a comfortable tool for the extension and handling of the ATM channel database is available.

The results must be recorded, not just for acceptance tests. All the virtual instruments of the Broadband Analyzer/Generator include a print function to allow you to produce hard copies that can be used for presentations.

The Broadband Analyzer/Generator is particularly suitable for end to end or Multicall test applications. The concept allows new connections, network nodes or network terminations to be tested simply and reliably on the customer's premises. These tests can also be automated if they are performed using signaling and SVCs.

Multicall test application

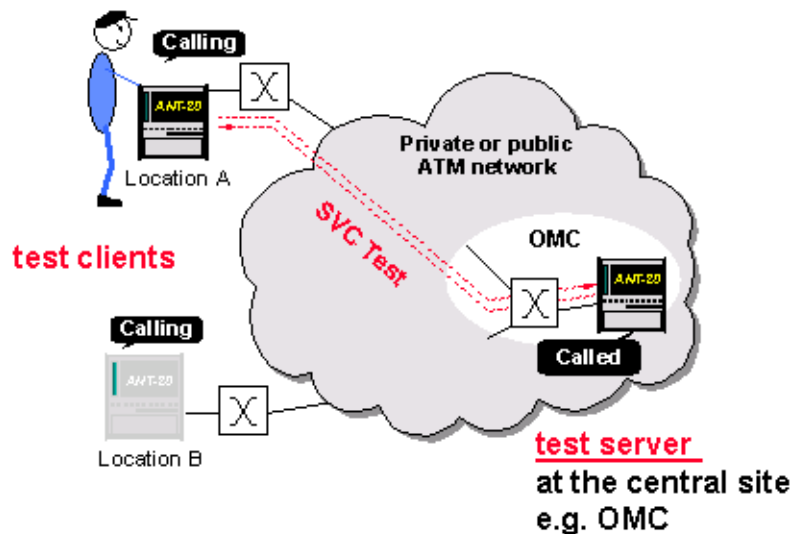

Fig. I-5 Multicall applications using the Broadband Analyzer/Generator
Several Broadband Analyzer/Generators are calling a "Call-server"
OMC: Operation & Maintenance Center



3 Test applications

3.1 ATM performance analysis

The basic version of the tester supports analysis of the ATM layer “Quality of Service”. Measurements are performed in conformance with ITU-T Recommendation O.191, “SPECIFICATIONS OF MEASURING EQUIPMENT; Equipment to Assess ATM Layer Cell Transfer Performance”.

This standard describes the currently most reliable ATM measurement method. It basically defines test cell formats and evaluation algorithms such as a 4-byte sequence number, the timestamp and a CRC16 check per cell.

By these definitions, test results in accordance to O.191 were registered, which can be compared directly.

The following quality parameters are reliably and unambiguously determined from the test cell data using the measurement algorithm:

- Error-related network performance parameters
 - CER, Cell Error Ratio
 - CLR, Cell Loss Ratio
 - SECBR, Severely Errored Cell Block Ratio
 - CMR, Cell Misinsertion Rate
- Availability-related network performance parameters
 - LPAC, Loss of Performance Assessment Capability
- Delay-related network performance parameters
 - CTD, Cell Transfer Delay
 - CDV, Cell Delay Variation

Using this measurement method, particularly precise long term measurements are possible which allow evidence of the constant high quality of a connection to be obtained.

3.2 Traffic management tests

Various test functions assist you in testing the ATM traffic management functions or to optimize their settings.

In particular, the tester supports the following:

- Definition and agreement of the ATM traffic contract for ATM circuits
- Checking the contract guarantees: Cell rates, cell losses, cell delay
- Tests using the “leaky bucket” algorithm (GCRA, generic cell rate algorithm)
- Simulations with traffic shaping
- Compliance and conformance simulations with ATM circuits and ATM sources
- Tests in connection with connection admission control
- Tests of UPC (usage parameter control) functions
- Analysis of cell loss priority control
- Tagging tests
- Explicit forward congestion analysis

In preparation:

- AAL-5 frame discard testing



3.3 UNI signaling tests

The “Signaling Emulation” function allows you to test the signaling characteristics of UNIs. Signaling emulation provides a rapid “go/no go” assessment of the following:

- Is it possible to set up a connection?
- What address format is supported?
- Which contract parameters can be negotiated?
- Which service categories can be used?
- Does the signaling process operate without problems?

3.4 Analysis of ATM signals

The ATM Channel Explorer is used to analyze ATM signals. This tool, for example can perform rapid diagnostics by finding the active ATM channels and displaying their bandwidth and AAL distributions. A further application is the detection of defects and anomalies in the ATM signal.

3.5 Other fields of application

The range of applications for the Broadband Analyzer/Generator is very wide and includes the following fields:

- Function tests for ATM network elements and modules
- Performance management
- Remote-controlled measurement of demand
- ATM network monitoring
- Acceptance tests
- Commissioning of ATM network nodes and ATM connections
- Commissioning of new ATM services



4 Using and setting up the Broadband Analyzer/Generator

The Broadband Analyzer/Generator is a flexible test concept for performing tests on the various protocol layers.

The diagram shows the points of access that the ATM tester can use within the layer model. It also shows the modular structure of the Windows user interface in conjunction with the generator and receiver hardware.

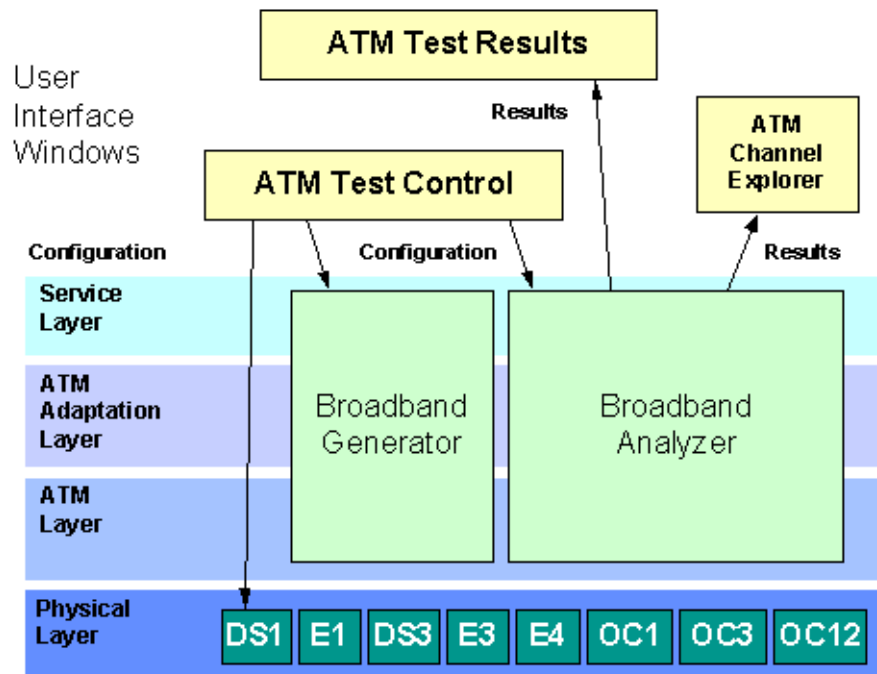

Fig. I-6 Hardware and software structure of the Broadband Analyzer/Generator

The modern operating concept and the user interface have been developed to allow you to perform tests simply and reliably. The number of operating steps needed has been reduced to a minimum:

1. Select the required instrument configuration
2. Select the test type
3. Select and edit the default test parameters where necessary
4. Start the measurement

The generator produces a test data stream in accordance with the selected test type and the analyzer outputs the test results in optimized form.

If one of the pre-defined applications in the Application Manager matches your test requirements exactly, it can be started immediately. This also applies to any applications that will be defined or modified by yourself. Own applications are easily made by storing instrument settings once with the Application Manager.

The stock of applications you create, together with the universal channel database allows the ATM tester to be rapidly adapted to new, complex test situations.



5 Overview: Virtual Instruments, “VIs”

To make it easier to locate and operate the large number of instrument functions, a user interface was developed for the ANT-20SE family of instruments that makes use of the concept of virtual instruments or “VIs”. The VIs are designed so that each has a clearly defined set of tasks. By selecting specific VIs, tools or “applications” can be developed and tailored to perform particular measurement tasks. The VIs for the Broadband Analyzer/Generator are summarized briefly below.



Virtual instrument		Protocol layer			Function
Icon	Name	Physical	ATM	Higher	
	ATM Test Control	•	•	•	Configure the test connection, signaling emulation and protocol layers for ATM measurements. Define measurement modes and virtual channels. Control traffic generation. Insert errors in the ATM and higher layers.
	ATM Test Results	•	•	•	Display and output the results of the ATM measurements made.
	ATM Channel Explorer	•	•	•	Characterize ATM traffic at the standard interfaces and trace alarms in the ATM layer (up to 1000 channels). Perform AAL layer analysis.

Table I-1 Virtual instruments for the Broadband Analyzer/Generator



6 Often used terminology

Application

An application consists of a suitable collection of virtual instruments (VIs for short) used to solve a measurement task. In this way applications can be defined e.g. for physical layer or ATM layer measurements.

Applications are configured and managed in the “ANT20 - <Application Title>” window (Application Manager VI).

If an application is saved, the parameter settings for the VIs used will also be saved.

In the same way, the measurement results are also saved with the application.

When the application is loaded, the test equipment is automatically set to the same settings as when the application was last used.

Test type

The “test type” is a concept used for ATM measurements. Test types are used to simply and quickly configure the instrument and prevent operating errors, particularly if signaling emulation is being used.

A test type consists of a measurement mode (only “ATM-Layer QoS” is available in this software version) and a “connection mode”.

When a test type is selected, the instrument is pre-set for performing the measurement. A setup dialog is provided for each test type so that you can make settings that are specific to the test you want to perform.

The settings for all test types used are saved within an application. When an application is loaded, the last test type used in the application will automatically be activated.

Example test types:

- ATM Layer QoS (PVC) - Point-to-point
- ATM Layer QoS (SVC) - Calling
- ATM Layer QoS (SVC) - Self-Call

Connection mode

The “connection mode” indicates the way that the virtual connection is switched through the ATM layer.

Example connection modes:

- For permanent virtual connections (PVC):
 - Point-to-point
 - Looped
- For switched virtual connections (SVC):
 - Calling (switched point-to-point connection with calling instrument)
 - Called (switched point-to-point connection with called instrument)
 - Self-Call (switched connection with self-call)



Port configuration

The Port configuration (topology) describes the way in which the test equipment is connected to the device under test on the physical layer.

Example topologies:

- Emulate
- Looped (between generator and receiver)
- Monitor (not yet supported)

Traffic type

The traffic type indicates the type of traffic contract. This term is defined by the ATM Forum. The ITU equivalent term is “broadband bearer capability”.

A traffic type must be specified for each virtual channel defined in the Channel Editor of the “ATM Test Control” VI.

Example traffic types:

- CBR (constant bit rate)
- VBR-nRT (variable bit rate, non real time)
- DBR (deterministic bit rate)
- SBR (statistical bit rate)

The CBR and DBR traffic types are identical in most respects. This is also true of the VBR-nRT and SBR traffic types.

Switched Virtual Circuit (SVC)

- Forward is the direction from the “calling” device to the “called” device.
- Backward is the direction from the “called” device to the “calling” device.

Permanent Virtual Circuit (PVC)

- Forward is the send direction of the device.
- Backward is the receiving direction of the device

Device means: ANT-20SE.



Operation

1 ATM Test Control

1.1 Introduction

Task

The “ATM Test Control” VI is used to select a test type and to configure the instrument for the selected test type. You can also control the running of the test from this VI if the selected test type allows for manual control (“Test - Online Control” dialog). Each test type generally includes configuration of the generator and the receiver.

The instrument configuration covers selection of the port configuration (topology), setting the various protocol layers, in particular the ATM layer and higher layers, as well as selection of the type of connection, i.e. “permanent” or “switched”.

The “test types” available for selection are used to structure measurement types and connection modes. These are arranged according to protocol layers, with only the ATM layer being supported at present. Only those test types that are possible and practicable with the selected instrument configuration are available for selection.

On-line control allows relevant test parameters to be altered during the traffic generation. This is particularly useful for traffic parameters such as the peak cell rate or mean cell rate, allowing rapid assessment of the effects of these parameters on the behavior of the device under test. On-line control also allows errors (anomalies and defects) to be inserted into the test cell stream.

The “ATM Test Control” VI is normally used together with the “ATM Test Results” VI. The latter displays the test results as determined by the selected test type and corresponding instrument configuration.

The settings made for a certain test type are saved within an “application” and are set again automatically when the test is called up again. Bit error measurements in the physical layer are not supported by the “ATM Test Control” VI.

Requirements

- ✓ The “Signal Structure” VI must also be loaded when performing ATM measurements. This is used to control and configure the physical layer, e.g. select the bit rate, frame type, etc. The instrument can also be configured for bit error measurements in the physical layer with the “Signal Structure” VI. If the “ATM Test Control” VI is loaded, the “Signal Structure” VI can only be accessed via the “Instrument Configuration” dialog of the “ATM Test Control” VI.
- ✓ To perform detailed tests in the physical layer, the “Anomaly/Defect Insertion” and “Anomaly/Defect Analyzer” VIs should also be loaded. The “Anomaly/Defect Insertion” VI allows insertion of a wide range of anomalies and defects in the physical layer. The “Anomaly/Defect Analyzer” VI provides corresponding analysis of the anomalies and defects in the physical layer.



Restrictions

The following virtual instruments cannot be used within a single application at the same time as the “ATM Test Control” VI: “ATM Signal Structure”, “ATM Background Generator” and “ATM Traffic Analyzer”

1.2 “ATM Test Control” window layout and commands

The “ATM Test Control” main window appears after the VI is loaded. It basically consists of a menu bar, toolbar and workspace containing the current configuration diagram. Most functions can be executed via menu commands (text) or via the icons in the toolbar.

When you select a menu command or an icon, a dialog window for making further settings may appear in the foreground.

Menu bar and toolbar

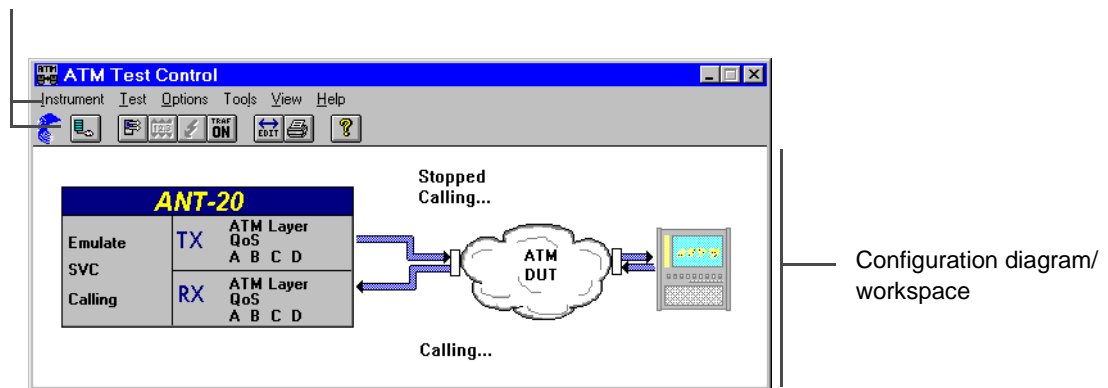

Fig. O-1 “ATM Test Control” main window

The “ATM Test Control” main window essentially consists of

- the menu bar and pull-down menus,
- the toolbar and
- the workspace with configuration diagram.

Menu bar

The menu bar contains a range of pull-down menus for selecting the following commands or groups of commands:

Instrument	Configure instrument
Test	Select test type, set test parameters (on-line, off-line), insert errors and control traffic enable
Options	Select optional settings
Tools	Define, handle and print out virtual channels
View	Customize the application window
Help	Use on-line help



Toolbar

The toolbar buttons provide direct access to the more important functions of the VI. Meanings of icons, from left to right (equivalent menu command shown in brackets):

Icon	Meaning
	Configure instrument (Instrument - Configuration ...)
	Select test type, set test parameters (Test - Setup ...)
	Alter source parameters "on-line"(Test - Online Control ...)
	Insert errors (Test - Error Insertion ...)
	Enable test traffic (Test - Traffic Enable)
	Define and handle virtual channels (Tools - Channel Editor ...)
	Print list of virtual channels (Tools - Print Channel List ...)
	Open on-line help (Help - Contents)

Table O-1 Meanings of icons

Configuration diagram

The main window workspace always displays a pictogram of the actual measurement configuration. If the configuration requires a second instrument, this will also be shown. Further information describes the configuration and the instrument status in detail:

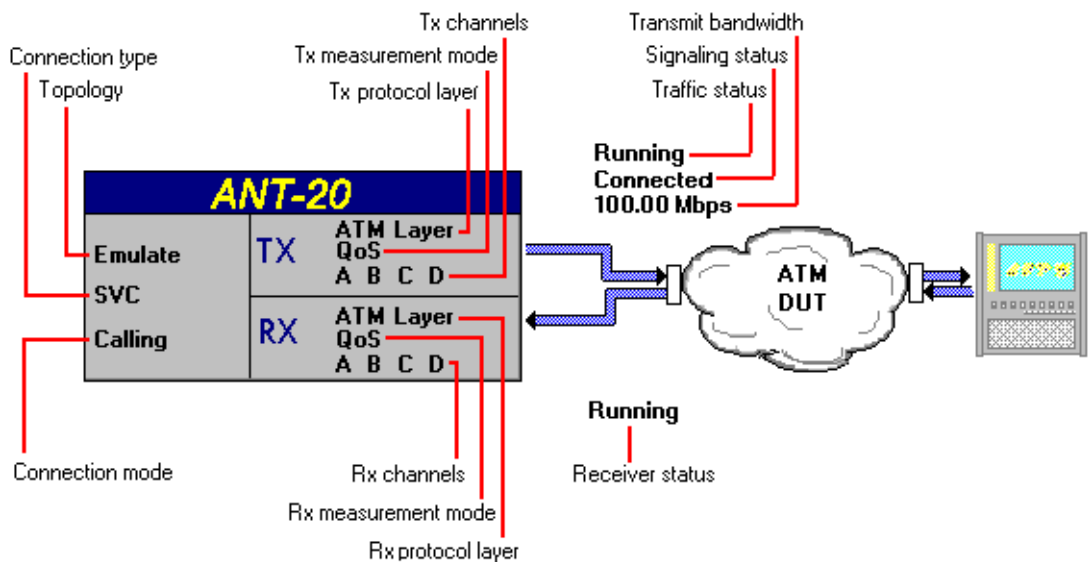

Fig. O-2 Display of "Port configuration" (Main window "ATM Test Control" VI), Example: "Emulate" and switched virtual circuit (SVC)

1.3 Important dialog windows

The “Instrument Configuration” dialog

The “Instrument Configuration” dialog is used to set the port configuration or topology for the measurement task and to match the instrument to the protocol layers used. You can also select whether permanent (PVC) or switched (SVC) virtual connections are to be tested. If switched virtual connections are selected, you can also configure the signaling emulation and set the ATM address of the instrument in this dialog.

The dialog shows the selected configuration in graphical form along with push buttons that open further dialogs for a given layer. This is also the case for the physical layer; the “Signal Structure” VI is opened when the “PHYSICAL” button is clicked, assuming that the “Signal Structure” VI has been loaded in the current DUT application; see Sec. 4.4, Page O-19.

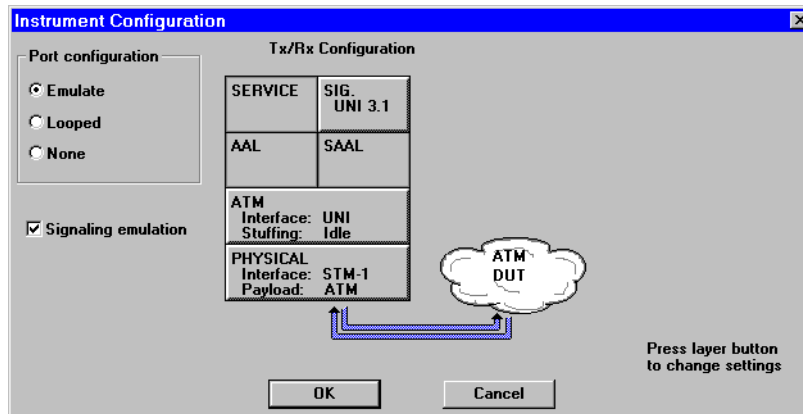

Fig. O-3 “Instrument Configuration” dialog

The “Test Setup” dialog

The “Test Setup” dialog is used to select the appropriate test type for your measurement task. Depending on the requirements and modifications with respect to the default setup, further dialog windows can be called up to configure your test type.

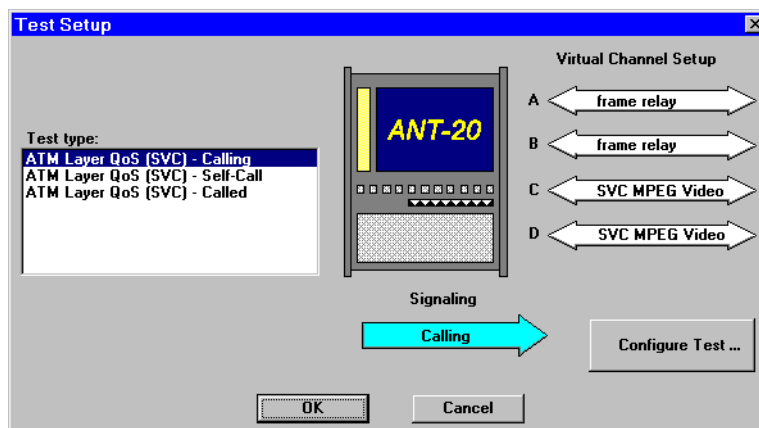

Fig. O-4 “Test Setup” dialog with available test types



The extended “Test Setup” dialog

The “Test Setup <...>” dialog is used to configure the test type and to match it to your measurement task (see Sec. 5.9).

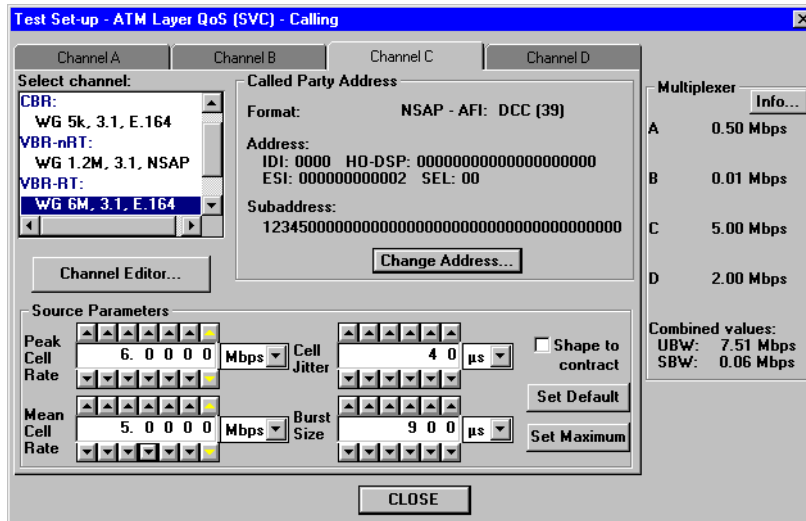

Fig. O-5 The extended “Test Setup <...>” dialog

The “Channel Editor” dialog

The Channel Editor is used to define virtual channels and save them in a database; Sec. 6, Page O-38. Push buttons and a list box in the dialog window header are used for defining and handling the channels. When first used, the list contains a range of default virtual channels for the usual types of traffic (CBR, VBR, etc.). These channels can be saved under a new name and edited individually.

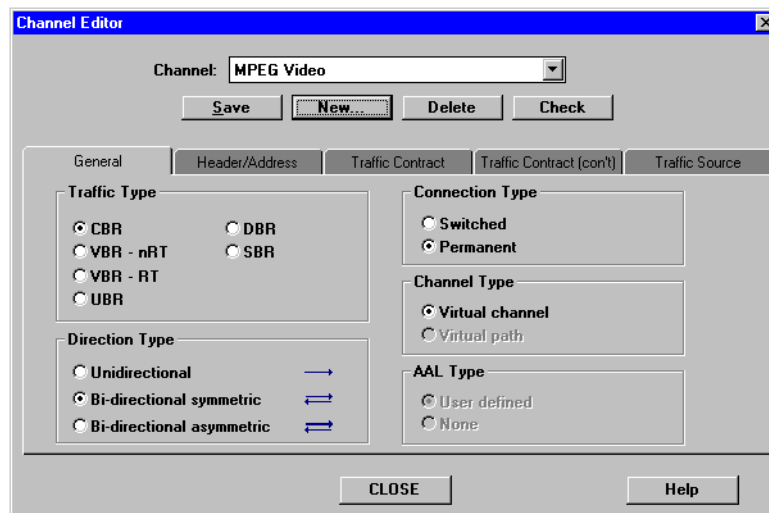

Fig. O-6 The “Channel Editor” dialog



The “Test Online Control - <...>” dialog

The source parameters of interest for your measurement task can be altered using the “Test Online Control - <...>” dialog as the test cell stream is being generated while a measurement is running. Any changes made become effective immediately. The channels (A, B, etc.) are controlled from separate index cards.



Fig. O-7 The “Test Online Control <...>” dialog

The “Test Error Insertion <...>” dialog

The “Test - Error Insertion” dialog is used to insert test-specific errors (anomalies and defects) into the test cell stream. The channels (A, B, etc.) are controlled from separate index cards.

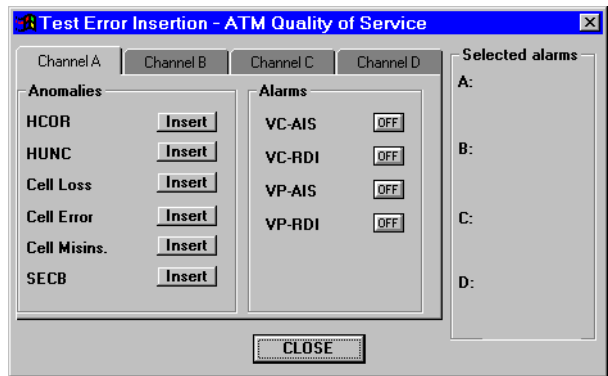

Fig. O-8 The “Test Error Insertion <...>” dialog



2 ATM Test Results

2.1 Introduction

Task

The “ATM Test Results” VI is used to display the results of measurements performed using the “ATM Test Control” VI. The results windows are configured depending on the active “Test type” set in the “ATM Test Control” VI. The following results windows may appear in the workspace of the “ATM Test Results” main window:

- “**Receiver Status**” window; this gives an overview of the overall receiver status.
- “**Quality of Service**” window; this displays the ITU-T O.191 QoS performance parameters. The results from a maximum of four test channels are displayed: Cell Error Ratio, Cell Loss Ratio, Cell Misinsertion Rate, Mean Cell Transfer Delay, etc.
- “**Signaling Analysis**” window; this displays the results of signaling analysis.

Requirements

- ✓ The “ATM Test Results” VI is primarily intended for use with the “ATM Test Control” VI.

Restrictions

The following virtual instruments cannot be used within a single application at the same time as the “ATM Test Results” VI: “ATM Signal Structure”, “ATM Background Generator” and “ATM Traffic Analyzer”.

Tip: Detailed analysis of the physical layer is performed using the “Anomaly/Defect Analyzer” VI which can be used at the same time as the “ATM Test Results” VI.

2.2 “ATM Test Results” main window layout and commands

The “ATM Test Results” main window appears after the VI is loaded. The display area contains separate windows for the receiver status, QoS results and signaling analysis.

The commands for selecting and arranging the results windows and for outputting data are found in the menu bar. The main commands are also available as icon buttons in the toolbar.

The “ATM Test Results” main window essentially consists of

- the menu bar and pull-down menus,
- the toolbar and
- the workspace with results window.



Menu bar and toolbar

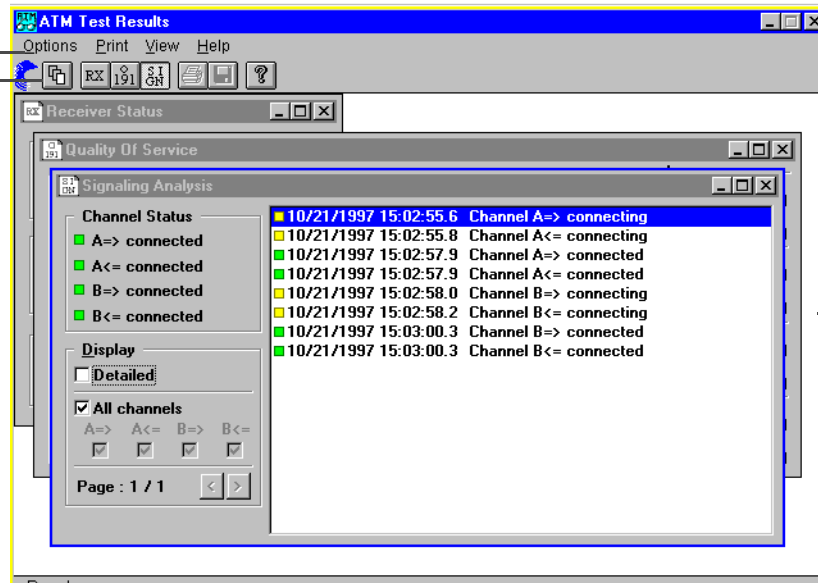

Result window/
workspace

Fig. O-9 "ATM Test Results" main window

Menu bar

The menu bar contains a range of pulldown menus for selecting the following commands or groups of commands:

- Options** Select optional settings for the record file for signaling measurements.
- Print** Print out or export the results.
- View** Customize the application window.
- Help** Use on-line help.

Toolbar

The toolbar buttons provide direct access to the more important functions of the VI: Functions for arranging the results windows, for printing out and exporting the results. Other functions for customizing the screen display are found in the menu bar.

Meanings of icons, from left to right (equivalent menu command shown in brackets):

Icon	Meaning
	Cascade the results windows (View - Cascade)
	Display receiver status (View - Receiver Status)
	Display Quality of Service parameters (View - Quality Of Service)
	Display signaling events (View - Signaling Analysis)

Table O-2 Meaning of icons





Icon	Meaning
	Print results (Print - Print ...)
	Export results (Print - Export ...)
	Open on-line help (Help - Contents)

Table O-2 Meaning of icons (*continue*)

2.3 Results window

After the measurement has been started, the measurement data are written continuously to the display fields of the individual windows.

After the VI is loaded, the workspace contains the following result windows in their default configuration:

“Receiver Status”

The “Receiver Status” results window gives a quick overview of the status of the receiver. This window is always displayed in the workspace, regardless of the current type of test.

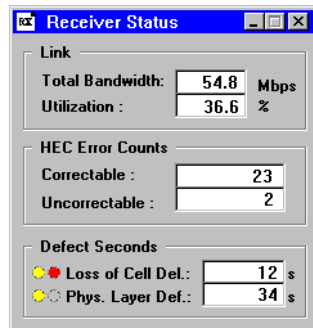

Fig. O-10 “Receiver Status” results window

“Quality Of Service”

The “Quality Of Service” results window (Fig. 11, Page 2-10) shows the ITU-T O.191 QoS performance parameters. The index cards of the window show detailed, channel-specific results. The right-hand section of the window is always visible and shows the alarm states for all channels.

The VI displays the QoS performance parameters of up to four permanent virtual circuits (PVC) or switched virtual circuits (SVC) simultaneously.

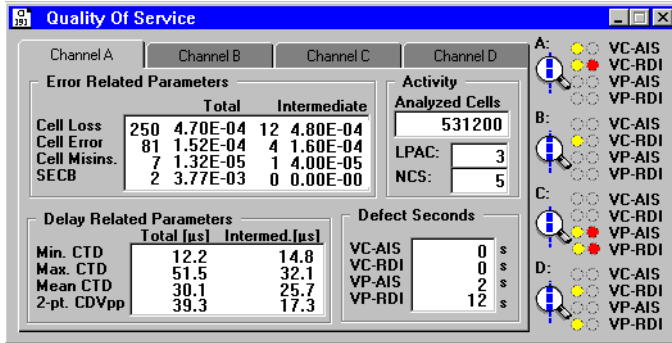

Fig. O-11 "Quality Of Service" results window

"Signaling Analysis"

A record of the signaling is made and displayed in the "Signaling Analysis" window for each measurement on switched virtual circuits (SVC). The record is saved in a Log File. If the "Log QoS Parameters" option is activated, the results for the QoS parameters are also saved in the log file when the circuit is teared down. The results of "ATM Layer QoS (SVC) <...>" type measurements can be recorded completely in this way. This is particularly useful if an instrument is operated in "Called" mode without supervision over a long period of time.

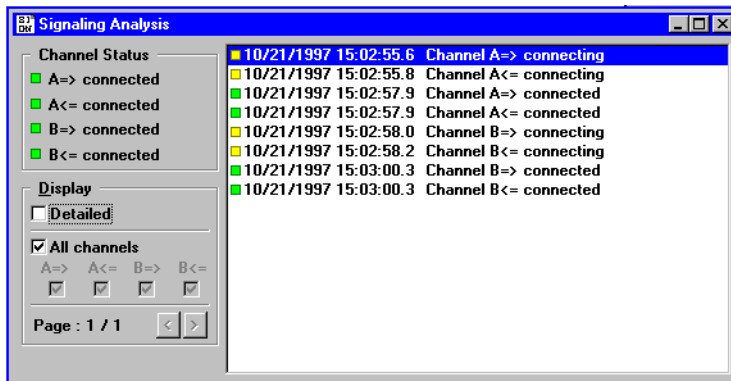

Fig. O-12 "Signaling Analysis" results window



3 ATM Channel Explorer

3.1 Introduction

Task

The “ATM Channel Explorer” VI is a tool for observing and interactively analysing activity on an ATM Link. The Channel Explorer provides various types of “Scans” and “Analyses” for this purpose.

The selection of the Scan type determines the criteria that the instrument uses to investigate the data stream that is present. Channels that match the corresponding criteria are recorded in the VI database and displayed in a list of results.

“Activity” Scan

“Activity” Scan registers all existing virtual channels up to a maximum count of 1000. Important attributes of the channels are determined, such as VPI/VCI value and various bandwidth informations. The channels recorded in the database can be subjected to various analyses, such as AAL type analysis.

“Trouble” Scan

“Trouble” Scan registers all virtual paths (VPs) and virtual channels (VCs) where an alarm state (AIS or RDI) is present, up to a maximum count of 1000. VP (F4) and VC (F5) layer results are listed separately.

Requirements

- ✓ To operate the “ATM Channel Explorer” VI, the “Signal Structure” VI must also be loaded so that the instrument can be matched to the physical layer. The receiver of the instrument must be configured for ATM operation to operate the Channel Explorer.

Restrictions

The following virtual instruments cannot be used at the same time as the “ATM Channel Explorer” VI within an application (applies to ANT-20 only): “ATM Signal Structure”, “ATM Background Generator” and “ATM Traffic Analyzer”.

The Channel Explorer can only be used if **no** other measurements have been started with the Application Manager and no test traffic is enabled.



3.2 “ATM Channel Explorer” window layout and commands

The “ATM Channel Explorer” main window with the result list appears after the VI is loaded.

The commands for configuring and starting the Scan functions are found in the menu bar. In addition, there are commands to perform analyses, to sort the output and to output results. The main commands are also available as icon buttons in the toolbar.

Menu bar and toolbar

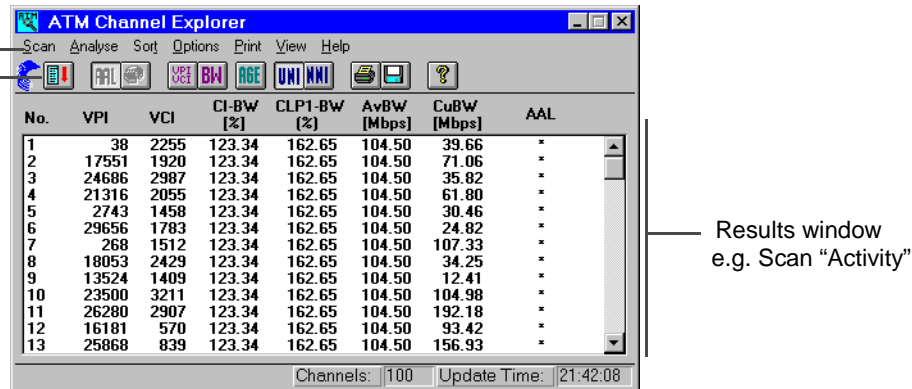

Fig. O-13 “ATM Channel Explorer” main window with results list

The “ATM Channel Explorer” main window essentially consists of

- the menu bar and pull-down menus,
- the toolbar and
- the workspace with results window.

Menu bar

The menu bar contains a few simple pulldown menus for selecting the following commands or groups of commands:

Scan	Select Scan type, start and stop Scan.
Analyse	Select Analysis type and perform analysis.
Sort	Select sort criterion.
Options	Select ATM interface.
Print	Print out or export the Scan results.
View	Customise the application window.
Help	Use on-line help.



Toolbar

The toolbar buttons provide direct access to the more important functions of the VI:

- Triggering the Scan function
- Triggering AAL analysis
- Sorting
- Preselecting the interface
- Printing and exporting the results.

Meanings of icons, from left to right (equivalent menu command shown in brackets):











Icon	Meaning
	Start and stop Scan (Scan - Start)
	Analyse AAL type in the active channel (Analyse - AAL Type)
	Display AAL Type Distribution as a pie chart (Analyse - AAL Type Distribution)
	Sort channels by VPI/VC1 values (Sort - VPI/VC1)
	Sort channels by bandwidth (load) (Sort - Bandwidth)
	Delete inactive channels (Options - Aging)
	Select UNI (Options - UNI)
	Select NNI (Options - NNI)
	Print results (Print - Print ...)
	Export results (Print - Export ...)
	Open on-line help (Help - Contents)

Table O-3 Meanings of icons



3.3 Results window

After the Scan has been triggered, the results are saved in the result memory and displayed in the appropriate results window according to the selected Scan type. The results memory can store up to 1000 channels per Scan. The results window can only show about 10 channels at once. The scroll bar at the side of the window can be used to view the remaining channels.

The order of the channels can be changed according to the Sort criterion selected in the “Sort” menu. The “Print” menu commands allow you to print out and to export the data to other programs for further processing.

Scan - Activity

The “Scan - Activity” investigates for active channels. The instrument detects every active channel and enters it in the results list. The results list is expanded until no new channels are detected or the maximum number of 1000 channels is reached. Each line corresponds to a channel. The columns in the results list contain the specific attributes of the channel.

Analyse - AAL Type

Detects and displays the AAL types for the active ATM channels.

Analyse - AAL Type Distribution

Determines and displays the distribution of active ATM channels according to AAL type. The “AAL Type Distribution” window appears showing the current distribution of active channels according to AAL type:

- Dynamic overview as a pie-chart display
- Quantitative display as a table of percentage values

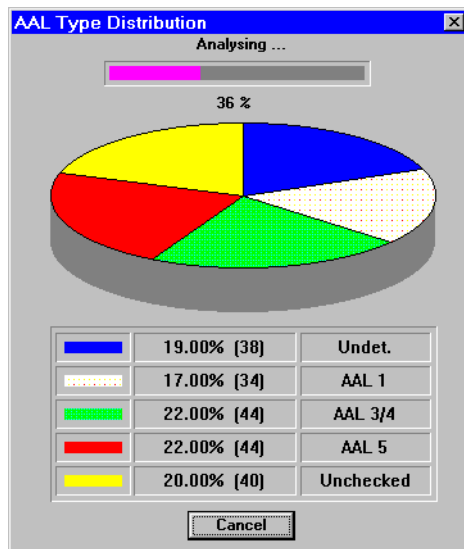

Fig. O-14 “AAL Type Distribution” results window



Scan - Trouble

“Scan - Trouble” checks for channels that are in an alarm state. The instrument detects every alarm message cell and enters the corresponding channel in the results list. There are two results windows corresponding to the error management hierarchy:

- F4 window: OAM Flow 4 (VP level)
- F5 window: OAM Flow 5 (VC level)

F4				F5				
No.	VCI	RDI	AIS	No.	VPI	VCI	RDI	AIS
1	2713	rdi	*	1	2445	2420	RDI	AIS
2	408	*	AIS	2	9225	1720	*	ais
3	474	rdi	*	3	5757	2184	*	ais
4	1164	*	AIS	4	19429	2075	*	ais
5	4659	RDI	ais	5	8250	2030	rdi	ais
6	294	rdi	ais	6	11137	2339	RDI	AIS
7	1994	RDI	ais	7	6950	614	*	ais
8	4186	rdi	AIS	8	687	2308	RDI	ais
9	3468	*	ais	9	278	1046	*	ais
10	22	RDI	*	10	12437	1250	rdi	AIS
11	1994	rdi	ais	11	20979	1014	RDI	AIS
12	1276	rdi	ais	12	16065	1711	RDI	ais
13	2178	rdi	AIS	13	7800	1281	rdi	AIS

Paths/Channels: 100 Update Time: 21:48:22

Fig. O-15 “Scan - Trouble” results display

4 Port configurations (topologies) and Instrument Configuration

VI: ATM Test Control

4.1 Overview

To simplify the basic setting of the instrument for ATM measurements, all the fundamental settings are made from a central dialog. This “Instrument Configuration” dialog handles the following:

- Selecting the topology (port configuration)
- Configuring the physical layer
- Configuring the ATM layer
- Enabling and configuring signaling emulation

4.2 The “Instrument Configuration” dialog



The “Instrument Configuration” dialog is used to set the port configuration or topology for the measurement task and to match the instrument to the protocol layers used. You can also select whether permanent (PVC) or switched (SVC) virtual circuits are to be tested. If switched virtual connections are selected, you can also configure the signaling emulation and set the ATM address of the instrument in this dialog.

The dialog shows the selected configuration in graphical form along with push buttons that open further dialogs for a given layer. This is also the case for the physical layer; the “Signal Structure” VI is opened when the “PHYSICAL” button is clicked, assuming that the “Signal Structure” VI has been loaded in the current application.

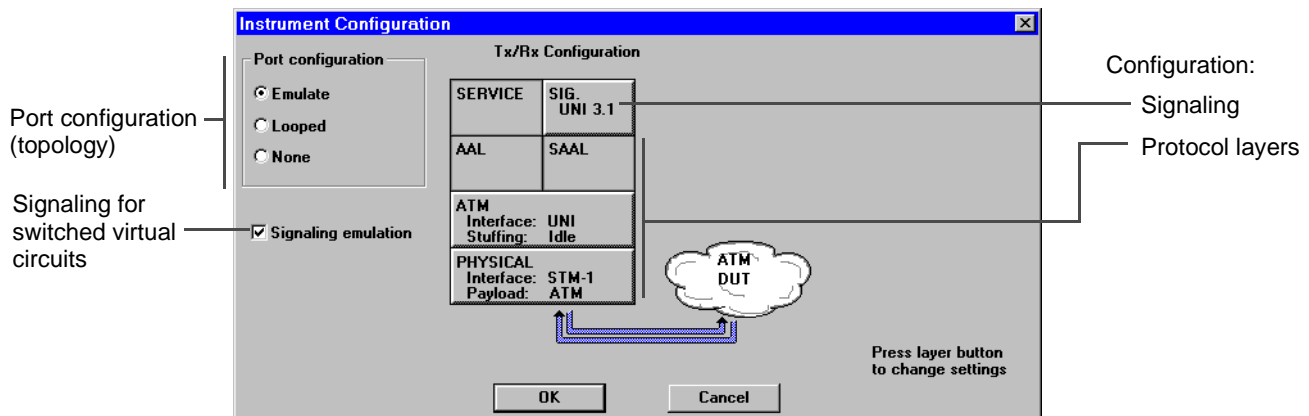

Fig. O-16 The “Instrument Configuration” dialog; e.g. with “Emulate” topology and signaling



The dialog contains the following sections:

Section	Meaning
Port configuration	Set the topology (Sec. 4.3, Page O-17)
Tx/Rx Configuration	Match the instrument to the protocol layers (Sec. 4.4, Page O-19)
Signaling emulation	Activate the signaling emulation
Buttons	Confirm configuration for all layers and closes the dialog Cancel configuration settings

Table O-4 "Instrument Configuration" dialog sections

4.3 Port configuration

The radio buttons in the "Port configuration" field are used to set the way in which the instrument is connected to the device under test (ATM DUT). The following topologies can be selected:

Emulate

The instrument's generator and receiver are connected to the same port of the device under test. This topology allows emulation with permanent or switched virtual connections. The "Emulate" topology must be used if signaling emulation is to be used. "Emulate" can only be selected if the physical layer bit rate and mapping are the same for the generator and the receiver and if an ATM mapping is selected.

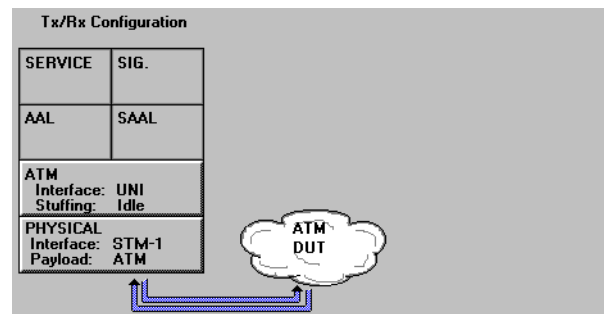

Fig. O-17 Dialog display, if "Emulate" topology is selected



Looped

The instrument's generator and receiver are connected to different ports, with the Tx signal looped back to the receiver. Using this topology, it is possible to configure the physical layer for different bit rates or mappings for the generator and receiver. An ATM mapping must, however, be selected for the Tx and Rx sides.

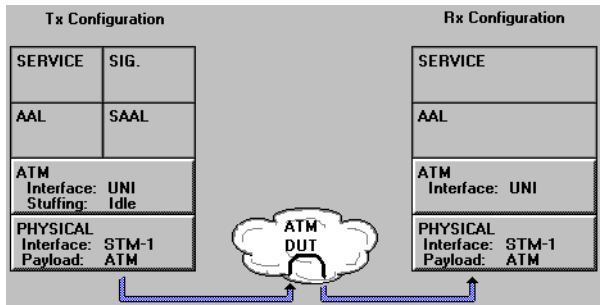

Fig. O-18 Dialog display, if "Looped" topology is selected

Disabled

Pseudo-topology indicating that ATM operation is disabled.

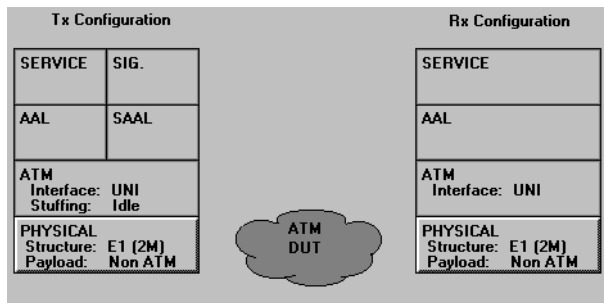

Fig. O-19 Dialog display, if "Disabled" option is selected



4.4 Tx/Rx Configuration

The buttons in the “Tx/Rx configuration” field are used to configure the individual protocol layers for the Tx and Rx sides of the instrument.

The buttons have the following meanings:

Button	Meaning
SERVICE ¹	Configure the ATM service layer
SIG ²	Configure the signaling protocol (Sec. 4.5.1, Page O-21)
AAL ¹	Configure the ATM adaptation layer
SAAL ¹	Configure the signaling AAL
ATM ³	Configure the ATM layer (Sec. 4.4.1, Page O-19)
PHYSICAL ³	Configure the physical layer (Sec. 4.4.2, Page O-21)

1 Actually not implemented.
 2 For Emulate topology with signaling emulation.
 3 This button is present for both Tx and Rx for Looped topology. It is only present once for Emulate topology.

Table O-5 Meaning of action buttons

Note: The most important layer-specific settings are shown on each button area. Buttons for non-relevant layers are disabled.

4.4.1 The “ATM Layer” dialog

This sub dialog is used to configure the ATM layer.

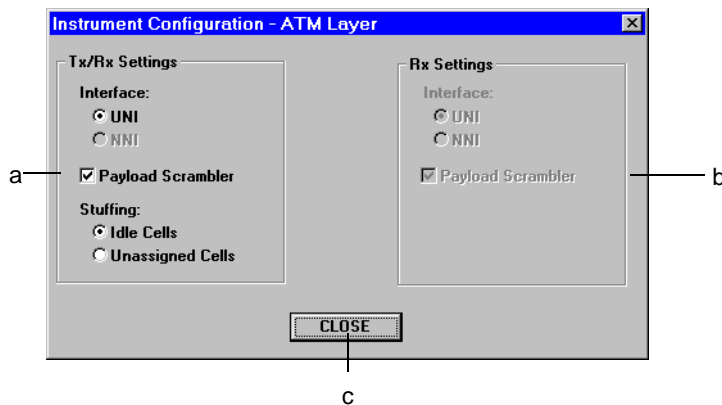

Fig. O-20 The “ATM Layer” sub dialog (“Emulate” topology)



The buttons and check boxes have the following meanings:

Radio buttons/Check boxes	Meaning
Tx/(Rx) Settings (a)	Generator (receiver) side parameters
Interface	Interface type "UNI" option: User-Network Interface "NNI" option: Network-Node Interface
Payload Scrambler	Activate/deactivate payload scrambler
Stuffing	Type of stuffing cells "Idle cells" option "Unassigned cells" option
Rx Settings (b)	Receiver parameters ¹
Interface	Interface type "UNI" option: User-Network Interface "NNI" option: Network-Node Interface
Payload Scrambler	Activate/deactivate payload scrambler
CLOSE (c)	Action button to confirm settings and return to main dialog.
¹ In Emulate topology, the Tx settings are also set for the receiver.	

Table O-6 Meaning of buttons and check boxes ("ATM Layer" sub dialog)

Additional buttons for "Looped" topology:

Button	Meaning
Tx => Rx	Copy Tx settings to the receiver
Tx <= Rx	Copy Rx settings to the generator

Table O-7 Additional buttons ("ATM Layer" sub dialog)



4.4.2 “Edit Signal Structure”

The “PHYSICAL” button brings the “Signal Structure” VI to the front if it was previously loaded using the Application Manager. The relevant parameters such as physical interface, bit rate, frame structure or mapping, etc. are set from this VI.

This button is provided for both Tx and Rx sides in “Looped” topology. The buttons both perform the same action.

When the “ATM Test Control” VI has been opened, settings in the “Signal Structure” VI can only be made via the mentioned “PHYSICAL” button. Direct opening of the “Signal Structure” VI by the Application Manager will cause disabling most of the edit boxes. This avoids undesired effects during instrument settings.

Note: Overhead bytes of the physical frame can be configured with the separate “Overhead Generator” VI.

4.5 Signaling emulation

The check box activates signaling emulation.

Check box checked: Allow switched virtual connections (SVC).

Check box unchecked: Only allow permanent virtual connections (PVC).

Note: Signaling can only be activated if “Emulate” topology has been selected. To configure the signaling, open the “Instrument configuration - Signaling Protocol” dialog using the “SIG”-button.

4.5.1 The “Signaling Protocol” dialog

This dialog is used to configure the signaling and to set the instrument ATM address (own call address). You should normally always enter an instrument address. This address is used as the called address in self-call mode.

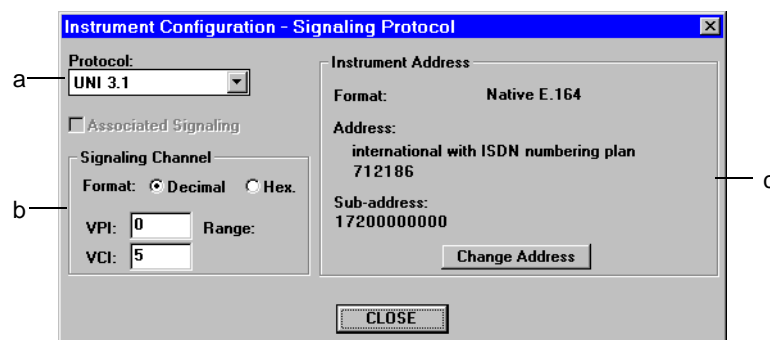

Fig. O-21 The “Signaling Protocol” sub dialog



The buttons and check boxes have the following meanings:

Button/Check Box	Meaning
Protocol (a)	Combo box with protocol types: UNI 3.0, UNI 3.1, Q.2931
Associated Signaling	Check box for selecting "Associated Signaling". This requires that the Q.2931 protocol is selected. With "Associated Signaling", the user channels are in the same virtual path (VP) as the signaling channel.
Signaling Channel (b)	Header value for the signaling channel.
Decimal, Hex.	Input format "Decimal" option: Decimal input "Hex" option: Hexadecimal input
VPI	Virtual path identifier
VCI	Virtual channel identifier
Range	Display field for VPI/VCI range of values
Instrument Address (c)	Address display and button for changing the instrument address
Format	Format display (e.g. Native E.164)
Address	Address display (various formats)
Sub-address	Sub-address display (if required)
Change Address	Enter own instrument address

Table O-8 Meaning of edit and check boxes ("Signaling Protocol" dialog)

4.5.2 The "Address Input" dialog

Accessed using the "Change Address" button. The dialog is used to set the instrument address (own call address).

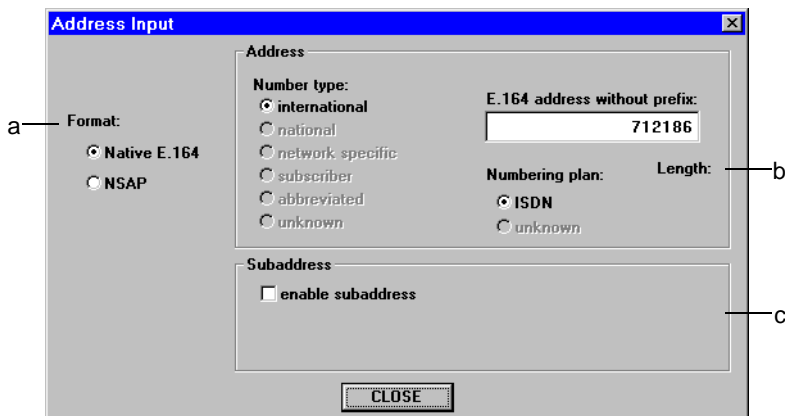

Fig. O-22 The "Address Input" sub dialog



The buttons and check boxes have the following meanings:

Button/Check Box	Meaning
Format (a)	Address format
Native E.164	Option for E.164 format
NSAP	Option for NSAP-format
Address (b)	Change address for "Native E.164" format or "NSAP" format
Subaddress (c)	Change sub-address

Table O-9 Parts of "Address Input" dialog

The "Address Input - Native E.164" box

Button/Check Box	Meaning
Button for	
Number type:	Type of address
international	- international
national¹	- national
network specific¹	- network-specific
subscriber¹	- subscriber-specific
abbreviated¹	- abbreviated
unknown¹	- unknown
Numbering plan:	Type of numbering plan
ISDN	- ISDN standard plan
unknown¹	- unknown plan
Check Box for	
E.164 address without prefix²	edit box for address (without 0 prefix)
Length	- Maximum number of characters
¹ Not always available, depends on protocol. ² Decimal.	

Table O-10 Parts of "Address Input" dialog

**The “Address Input - NSAP” box (not displayed)**

Button/Check Box		Meaning
Radio buttons for		
AFI ¹		Type of address (Authority and Format Identifier)
	ICD	- International Code Designator
	DCC	- Data Country Code
	E.164	- Public network code number, as per E.164
	E.191	- Public network code number (for Q.2931 only), as per E.191
Edit boxes for		
	IDI ²	Initial Domain Identifier
	HO-DSP ²	High Order Specific Part
	ESI ²	End System Identifier
	SEL ²	Selector
Display field		
Length		Number of characters for the selected edit box e.g. 4 for ICD-IDI
1 NSAP address: AFI (2 characters) + IDI + HO-DSP + ESI + SEL (length = 40). 2 Hexadecimal.		

Table O-11 Parts of “Address Input” dialog

The “Sub-address” box (NSAP)

This box is used to set a sub-address.

Box	Meaning
Enable Subaddress	Enables sub-address
Subaddress ¹	Edit box for sub-address (hexadecimal string)
Length	Number of characters (40)
1 Hexadecimal	

Table O-12 Parts of “Address Input” dialog



5 Test Types

5.1 Overview

“Test types” serve to structure the measurement modes and the so-called connection modes. A “test type” comprises a measurement mode and a connection mode. The connection mode defines how the virtual ATM connection is switched.

To allow precise line-up of traffic contracts, facilities must be provided to allow virtual connections to be switched between two or more test instruments. Some test types are designed for such configurations involving several test instruments. Software version 6.5 initially only provides support for the “ATM-layer Quality of Service” measurement mode; the following connection modes are possible:

Connection Mode		Meaning
For PVCs		
	Point-to-Point	The virtual connection is a point-to-point connection between two or more instruments.
	Looped	The virtual connection is a looped-back point-to-point connection. The loop-back can be either in the ATM layer or in the physical layer.
For SVCs		
	Calling	The virtual connection is a point-to-point connection between two or more instruments. The instrument initiates the call (calling instrument).
	Called	The virtual connection is a point-to-point connection between two or more instruments. The instrument takes the call (called instrument)
	Self-Call	The virtual connection is a looped-back point-to-point connection in the ATM layer. The instrument generates a self-call.

Table O-13 Possible connection modes

The test type is selected in the “Test Setup” dialog of the “ATM Test Control” VI. The configuration of the instrument determines which of the test types will be available for selection. Only those test types that are possible and meaningful for the given configuration setting are displayed for selection.

The table below indicates the test types that can be selected:

Test type	Signaling activated	Topology	Notes
ATM Layer QoS - Looped Topology	No	Looped	Only test type available for Looped topology.
ATM Layer QoS (PVC) - Point-to-point	No	Emulate	Two instruments required.
ATM Layer QoS (PVC) - Looped	No	Emulate	-

Table O-14 Übersicht der wählbaren Test types

Test type	Signaling activated	Topology	Notes
ATM Layer QoS (SVC) - Calling	Yes	Emulate	Two instruments required. Only possible on UNI.
ATM Layer QoS (SVC) - Called	Yes	Emulate	Two instruments required. Only possible on UNI.
ATM Layer QoS (SVC) - Self Call	Yes	Emulate	Only possible on UNI.

 Table O-14 Übersicht der wählbaren Test types (*continue*)

5.2 The “Test Setup” dialog: Setting the Test Type



The “Test Setup” dialog (see Fig. 23) is used to select the appropriate test type (a) for your measurement task. Click the “Configure Test” button (c) to configure the test. The extended “Test Setup <...>” dialog window opens.

The “Virtual Channel Setup” box displays the current virtual connection mode as a pictogram with the channel names as specified in the Channel Editor.

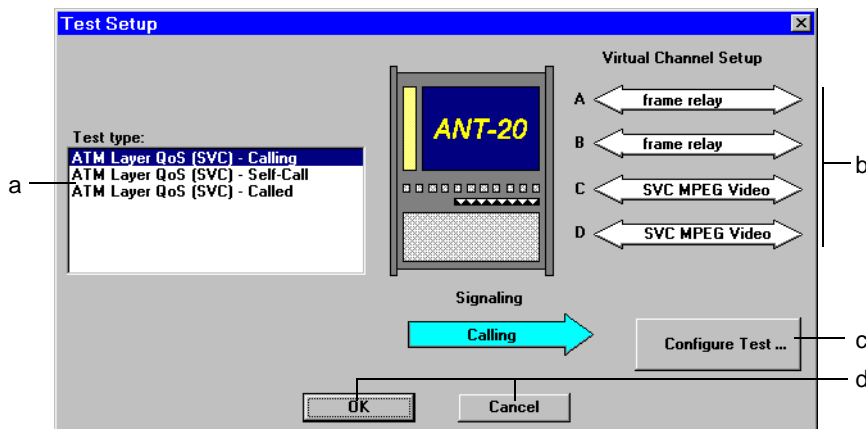

Fig. O-23 The “Test Setup” dialog with available test types, e.g. with types for switched virtual circuits (SVCs)



The “Test Setup” dialog consists of the following sections:

Section	Meaning	
Test type (a)	List of test types, depends on the actual instrument configuration.	
Virtual Channel Setup (b)	Display of current virtual connection mode as a pictogram with the channel names ¹ .	
		“Point-to-point”, “Calling” or “Called” connection mode
		“Looped” topology
		“Looped” or “Self-Call” connection mode
Configure Test (c)	Button for opening the “Test Setup - <...>” dialog to configure the test. (Sec. 5.9, Page O-32)	
Action buttons(d)	<p>OK: Confirm the selected test type and/or parameter settings in the “Test Setup - <...>” dialog and return to the main window.</p> <p>Cancel: Cancel the settings</p>	
<p>¹ Names as specified in the Channel Editor</p>		

Table O-15 “Test Setup” dialog sections

5.3 The “ATM Layer QoS - Looped Topology” test type

This test type is intended for ATM layer QoS measurements in Looped topology. This means that the transmitter and receiver are connected to different ports of the device under test (DUT), with the Tx signal looped back to the receiver.

Characteristics

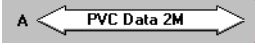
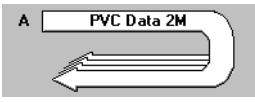
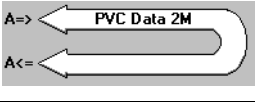
- Measurement of permanent virtual connections (PVC)
- Up to four virtual channels possible
- Cell delay measurements are possible
- Unidirectional or bi-directional channels can be tested. The parameters for the backward direction are ignored for bi-directional channels..

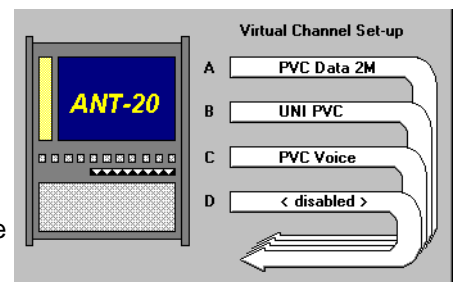

Basic instrument settings

- “Looped” topology

The pictogram shown opposite appears in the workspace of the VI.

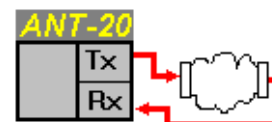



5.4 The “ATM Layer QoS (PVC) - Point-to-point” test type

This test type is intended for ATM layer QoS measurements with permanent virtual connections where channels are to be tested from end to end in both directions. This test is particularly effective in determining adherence to traffic contracts. Two test instruments are required.

Characteristics

- Measurement of permanent virtual connections (PVC)
- Up to four virtual channels possible
- Cell delay measurements are not possible
- Bi-directional, symmetrical or asymmetric channels can be tested.

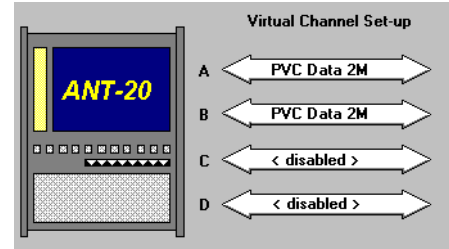

Basic instrument settings

- “Emulate” topology
- Signaling emulation “off”

The pictogram shown opposite appears in the workspace of the VI.

Tip: Configurations using more than two test instruments are also possible.

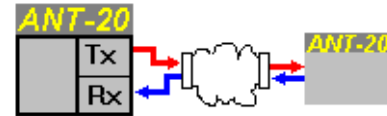



5.5 The “ATM Layer QoS (PVC) - Looped” test type

This test type is intended for ATM layer QoS measurements with permanent virtual connections where the virtual channels are to be looped back in the DUT either in the physical layer or in the ATM layer.

Loop-back in the physical layer

If you select **unidirectional** channels in the extended “Test Setup <...>” dialog, this corresponds to a loop-back in the DUT in the physical layer.

Tip: Only virtual channels with symmetrical bandwidth can be used with this method.

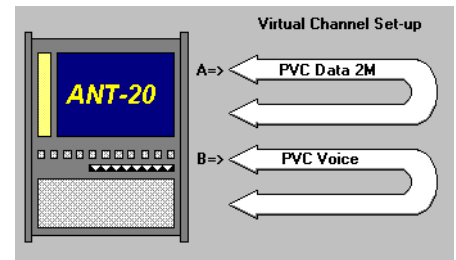

Characteristics

- Measurement of permanent virtual connections (PVC)
- Up to two virtual channels possible
- Cell delay measurements are possible
- Bi-directional, symmetrical channels can be tested. From the point of view of the DUT, the channels are bi-directional and symmetrical; from the test instrument point of view, the connection is a unidirectional loop.

Loop-back in the ATM layer

If you select **bi-directional** channels in the extended “Test Setup <...>” dialog, this corresponds to a loop-back in the DUT in the ATM layer.

Characteristics

- Measurement of permanent virtual connections (PVC)
- Up to two virtual channels possible
- Cell delay measurements are possible
- Bi-directional, symmetrical or asymmetric channels can be tested.

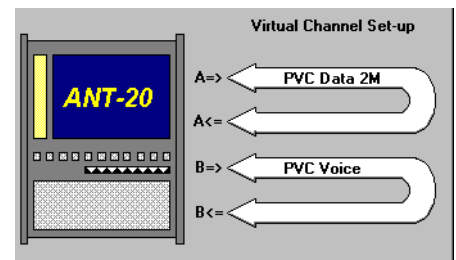

Basic instrument settings

- “Emulate” topology
- Signaling emulation “off”

The pictogram shown opposite appears in the workspace of the VI.

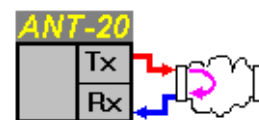

5.6 The “ATM Layer QoS (SVC) - Calling” test type

This test type is intended for ATM layer QoS measurements with switched virtual connections where channels are to be tested from end to end in both directions. Two test instruments are needed for the test, one acting as calling party and the other as called party. The instrument configured with this test type is the calling party.

This test is particularly effective in determining adherence to traffic contracts.

Characteristics

- Measurement of switched virtual connections (SVC)
- Up to four virtual channels possible
- Cell delay measurements are not possible
- Bi-directional, symmetrical or asymmetric channels can be tested.

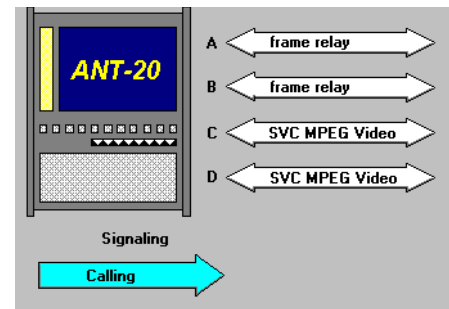

Basic instrument settings

- “Emulate” topology
- Signaling emulation “on”

The pictogram shown opposite appears in the workspace of the VI.

Tip: Configurations using more than two test instruments are also possible.

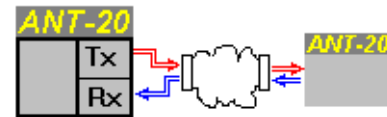

5.7 The “ATM Layer QoS (SVC) - Called” test type

This test type is intended for ATM layer QoS measurements with switched virtual connections where channels are to be tested from end to end in both directions. Two test instruments are needed for the test, one acting as calling party and the other as called party. The instrument configured with this test type is the called party.

This test is particularly effective in determining adherence to traffic contracts.

When the instrument accepts the call, it automatically configures its transmitter according to the contract parameters contained in the incoming Setup Message. The instrument then starts generating traffic (if traffic generation has been enabled by the user) and measuring the QoS parameters. Traffic generation ceases after the call is cleared down.

The instrument can be called as often as is required, but it can accept a maximum of four calls at one time. The calls can come from different (ANT-20SE) instruments at the far end operating in “Calling” mode.

The signaling processes and connection states are saved in a log file and displayed in the “ATM Test Results”. The measured QoS parameters can also be saved optionally in the log file.



Characteristics

- Measurement of switched virtual connections (SVC)
- Up to four virtual channels possible
- Cell delay measurements are not possible
- Bi-directional, symmetrical or asymmetric channels can be tested.

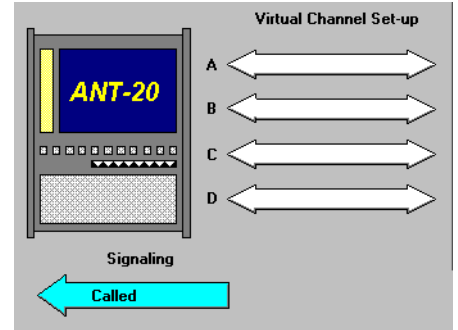

Basic instrument settings

- “Emulate” topology
- Signaling emulation “on”

The pictogram shown opposite appears in the workspace of the VI.

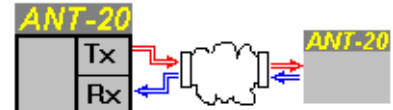

Tip: Configurations using more than two test instruments are also possible.

5.8 The “ATM Layer QoS (SVC) - Self Call” test type

This test type is intended for ATM layer QoS measurements with switched virtual connections. It is a self call, with the connection being looped back in the DUT in the ATM layer.

Characteristics

- Measurement of switched virtual connections (SVC)
- Up to two virtual channels possible
- Cell delay measurements are possible
- Bi-directional, symmetrical or asymmetric channels can be tested.

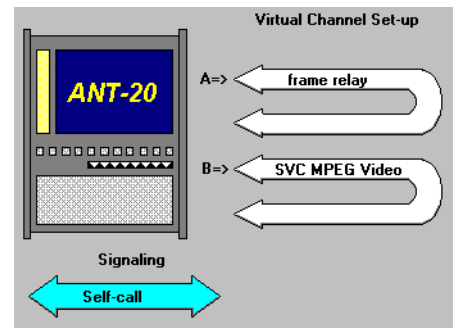

Basic instrument settings

- “Emulate” topology
- Signaling emulation “on”

The pictogram shown opposite appears in the workspace of the VI.

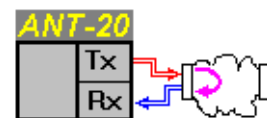

5.9 The “Test Setup <...>” dialog: Configure test type

Configure Test ...

The extended “Test Setup <...>” dialog is used to configure the test type and to match it to your measurement task. The test channels are represented here by index cards, e.g. “Channel A”, “Channel B”, etc. The index card labels are determined by the selected test type.

Virtual channels that you define in the “Channel Editor” are shown in a selection list. You can assign certain virtual channels from this stock of channels to the test channels A, B, etc. When you assign a virtual channel to a test channel in this way, all the corresponding parameters will be assigned to the test channel on the current index card in a single step. The first time that you open the dialog, the edit boxes on the index cards will be empty as no assignment has yet been made. This status is indicated in the selection list by the item <disabled>.

As a large number of parameters are required for complete definition of a channel (contract parameters, source parameters, etc.) only the most important parameters are shown on the index cards. You can overwrite these parameter values directly, without altering the standard definition of the channel in the “Channel Editor”. To view all the parameters for the virtual channel, call up the “Channel Editor” by clicking on the “Channel Editor” button.

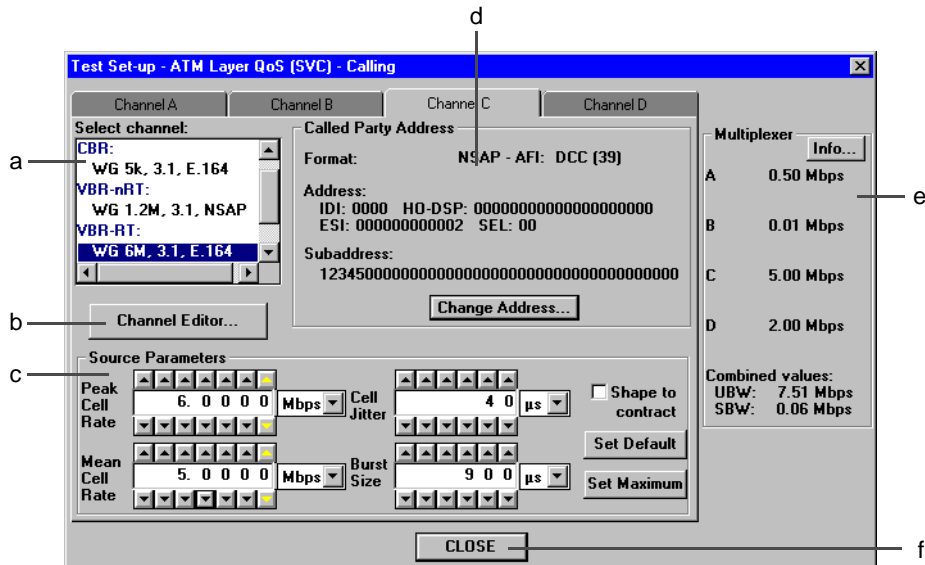

Fig. O-24 Extended “Test Setup <...>” dialog



The “Test Setup <...>” dialog may include the following sections:

Section	Meaning
Select channel (a)	Select pre-defined test channels (see Sec. 5.9.1)
Channel Editor ... (b)	Push button: Open the Channel Editor
Source Parameters (c)	Set the source parameters
Header (d) - or - Called party address - or - Own instrument address	Set the cell header parameters ¹ . Display / set the called party address ² . Display field: Own instrument address ³ .
Multiplexer (e)	Display field: Information about the ATM traffic multiplexer
CLOSE (f)	Push button: Confirm the settings and returns to the “Test Setup” dialog.
1 Input for PVCs 2 Input for SVCs in “Calling” mode 3 For SVCs in “Self Call” mode	

Table O-16 Section of the dialog “Test Setup <...>”

Certain relationships exist between parameters which depend on the current configuration. This means that the choice of parameters will not always be the same. To preserve clarity, the index cards only include the parameters that are relevant to the actual configuration or test type. Parameters that cannot be edited, and which are for information only, are grayed out. In particular,

- all index cards are empty in “Called” mode
- the index cards for the backward path are empty in “Self-Call” mode
- the index card for the backward path for the “ATM Layer QoS (PVC) - Looped” test type does not include a “Selected channel” box.

Parameter settings can only be made if the test traffic is disabled (“Test - Traffic Enable” must be deactivated).

5.9.1 Select channel

The “Select channel” list box contains a selection of virtual channel types that can be used to rapidly configure the test channels. The list is arranged in order of traffic type.

To preserve clarity, only those channel types that can be used with the current instrument configuration are shown in the list box, e.g. if a test type for permanent virtual connections (PVC) has been selected, no channels will be listed which are defined as switched virtual connections (SVC).

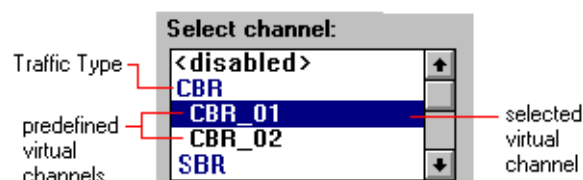

Fig. O-25 List box with pre-selected virtual channel types



The items in the list are arranged in alphabetical order of traffic type. The following traffic types are available:

Disabled	No test channel assigned; test channel is disabled
CBR	Constant bit rate traffic
VBR-RT	Real-time variable bit rate traffic
VBR-nRT	Non real-time variable bit rate traffic
DBR	Deterministic bit rate traffic
SBR	Statistical bit rate traffic
UBR	Unspecified bit rate traffic

5.9.2 Header

The “Header” field is used to define the test cell header for permanent virtual connections (PVC). Generally, the header values for the Tx and Rx sides are set separately.

The edit boxes and radio buttons have the following meanings:

Button/Box	Meaning
Format	Radio buttons for selecting the VPI/VCI format
Decimal	Input and display of the numerical values for Tx and Rx as decimal numbers
Hex.	Input and display of the numerical values for Tx and Rx as hexadecimal numbers
Tx	Tx side header values
UNI/NNI	Display indicating the interface to which the parameters apply
GFC	Generic Flow Control (for UNI only)
VPI¹	Virtual Path Identifier
VCI¹	Virtual Channel Identifier (Kennziffer des virtuellen Kanals)
CI	Congestion Indicator
CLP	Cell Loss Priority (High = 1, Low = 0)
Rx	Rx side header values
UNI/NNI	Display indicating the interface to which the parameters apply
VPI¹	Virtual Path Identifier
VCI¹	Virtual Channel Identifier
Range	Display of range of values for GFC, VPI, VCI
<small>1 A particular VCI/VPI combination can only be assigned once on the Tx or Rx side. This is checked before the test traffic is enabled. The allowed ranges for the VPI value differ for UNI and NNI.</small>	

Table O-17 Edit boxes and radio buttons of “Header” field



5.9.3 Called party address

This field is used to display and set the ATM address of the called party (in “Calling” mode).

Section	Meaning
Called Party Address	Address display and action button for changing the called address.
Format	Format type display (e.g. Native E.164)
Address	Address display (various formats)
Subaddress	Sub-address display (if required)
Change Address	Change address <ul style="list-style-type: none"> • for “Native E.164” format (Sec. 4.5.1, Page O-21) • for “NSAP” format (Sec. 4.5.2, Page O-22)

Table O-18 “Called party address” dialog sections

5.9.4 Own instrument address

This field is used to display the instrument's own ATM address as set in the instrument configuration. This address is used as the call address in self-call mode.

The display fields have the following meanings:

Section	Meaning
Own instrument Address	Own instrument Address
Format	Format type display (e.g. Native E.164)
Address	Address display (various formats)
Sub-address	Sub-address display (if needed)

Table O-19 “Own instrument address” dialog sections



5.9.5 Source parameters

The “Source Parameters” field is used to set the source parameters. These determine the load conditions for the channel (Peak Cell Rate, Mean Cell Rate) and the jitter and burst characteristics. When you select a test channel, the source parameters will be initialized with the default values pre-defined in the “Channel Editor”.

Each source parameter has its own increment / decrement buttons for entering the parameters. The units are selected from the adjacent list boxes.

The “Source Parameters” field consists of the following sections:

Section	Meaning
Peak Cell Rate	Peak cell rate (load) in Mbps, kbps or cps (cells/s).
Mean Cell Rate ¹	Mean cell rate (load) in Mbps, kbps or cps (cells/s).
Cell Jitter	Cell jitter in ms or μ s.
Burst Size ¹	Burst size in ms or μ s.
Shape to contract ²	Check box: Activate traffic shaper.
Set Default	Push button: Sets the source parameters to the pre-defined values on the “Traffic Source” (Channel Editor) index card.
Set Maximum ²	Push button: Sets the source parameters to their maximum possible values. These are determined by the traffic contract.
1 Not always available; depends on source type 2 Not always available; depends on conformance definition	

Table O-20 Source Parameters

With regard to the generated cell rate, the traffic generator has a high resolution range (for low cell rates) and a low resolution range (for high cell rates). If the low resolution range is active, the arrow keys for the lowest value digit of the increment / decrement keypad are highlighted in yellow.

The source parameters are interdependent, i.e. you cannot set a mean cell rate that is higher than the peak cell rate. Cell jitter and burst size are limited by the characteristics of the traffic generator. If a parameter value cannot be set as required, this may be due to the set values of other parameters. It is a good idea to set the parameters in the following order:

- Mean and peak cell rates
- Burst size
- Cell jitter

The maximum values for burst size and cell jitter are limited and depend on the settings of other parameters. Where appropriate, the burst size and cell jitter settings will be reduced automatically by the instrument.



5.9.6 Multiplexer

The entries made in the “Multiplexer” field have the character of a preview (traffic prediction) since the generator is not yet active during the setup. This makes it possible to set up the generator exactly before starting the measurement.

5.9.7 Channel labeling

In

- Looped and
- Self Call

Connection Modes, the instrument generates traffic on up to two channels in both directions. The channels are then labeled as follows on the index cards and in the Multiplexer field:

Channel A => Channel A, forward direction
Channel A <= Channel A, backward direction
Channel B => Channel B, forward direction
Channel B <= Channel B, backward direction

In the other Connection Modes, the instrument generates traffic on up to four channels in one direction. The channels are labeled as follows:

Channel A Channel A
Channel B Channel B
Channel C Channel C
Channel D Channel D



6 Defining Virtual Channels

VI: ATM Test Control

6.1 Overview

Virtual channel

The term “virtual channel” is central to ATM technology. A virtual channel is basically characterized by

- The type of virtual connection: switched (SVC) or permanent (PVC)
- The direction: unidirectional or bi-directional
- The virtual channel number (VPI/VCI) for permanent virtual connections or the ATM address for switched virtual connections
- The traffic contract which is basically defined by the “Conformance Definition”, the “Traffic Descriptor” and the “Quality of Service” class
- The AAL type
- For a measurement task it is usually also necessary to assign the channel to a traffic source which is defined by the source type and the source parameters.

As can be seen, a large number of parameters are used to fully define a virtual channel. The “Channel Editor” tool in the “ATM Test Control” VI has been provided to keep operations involving virtual channels as simple as possible.

The “Channel Editor” allows you to define, modify and copy channels. Each channel definition can be assigned a user-defined name.

Database

A channel database is included in the “Channel Editor”. This database is used to exchange channel definitions between applications and instruments.

One database is available per instrument. When a channel is used in an application, a copy of the channel is saved with the application. Each time the application is loaded, the instrument checks that the copy is identical to the channel definition in the database, or if the channel is still present in the database. If differences are found, the “Channel Import” dialog is displayed. This allows you to remove any inconsistencies between the application and the database. As a copy of each channel used is present in the application, the channels will automatically be exported when an application is exported to another instrument. These channels can be included into the database of the other instrument when the application is started there for the first time.

6.2 The “Channel Editor” dialog



The Channel Editor is used to define virtual channels and save them in a database. Push buttons and a list box in the dialog window header are used for defining and handling the channels. When first used, the list contains a range of default virtual channels for the usual types of traffic (CBR, VBR, etc.). These channels can be saved under a new name and edited individually.

Access to the various parameter groups is by means of index cards.

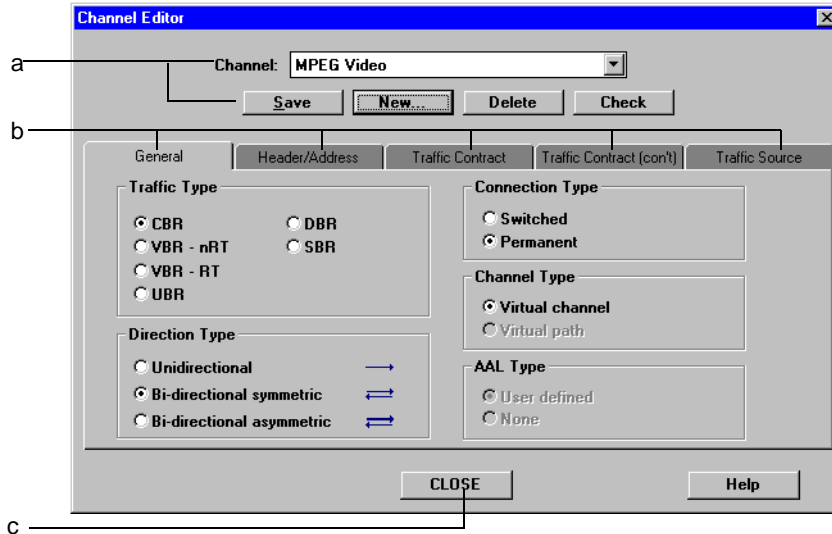

Fig. O-26 The “Channel Editor” dialog

The dialog contains the following sections:

Section	Meaning
Header (a)	
Channel	List box ¹ listing all saved virtual channels.
Save ²	Saves the virtual channel in the database under the current name
New	Creates a new virtual channel.
Delete	Deletes the marked virtual channel from the database.
Check ³	Checks the channel for consistency with the current configuration.
Index cards (b)	
General	For entering general channel parameters
Header/Address	For entering header information or addresses
Traffic Contract	For entering main traffic contract parameters
Traffic Contract (con't)	For entering further traffic contract parameters
Traffic Source	For entering source parameters
Buttons (c)	
Help	Push button: Calls up on-line Help.
CLOSE	Push button: Closes the dialog.
<p>1 Arranged in alphabetical order 2 Not available for write-protected virtual channels with names beginning with “W&G...” 3 A check is made to see if the channel can be assigned to a test channel in the current instrument configuration.</p>	

Table O-21 Sections of the “Channel Editor” dialog

6.3 Parameter display and modification (index cards)

6.3.1 The “General” index card

This index card defines the general parameters for the virtual channel selected in the “Channel” list box.

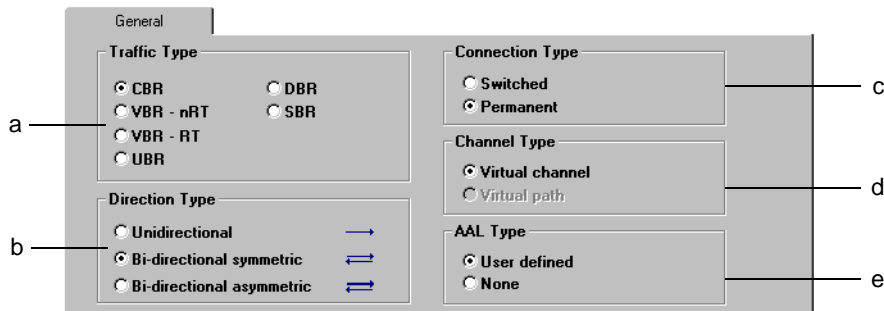

Fig. O-27 The “General” index card (Channel Editor)

The radio buttons have the following meanings:

Button	Meaning
Traffic Type (a)	Available traffic types (type of traffic contract)
<input checked="" type="radio"/> CBR	<ul style="list-style-type: none"> constant bit rate
<input type="radio"/> VBR - nRT	<ul style="list-style-type: none"> variable bit rate (non real time)
<input type="radio"/> VBR - RT	<ul style="list-style-type: none"> variable bit rate (real time)
<input type="radio"/> CBR	<ul style="list-style-type: none"> unspecified bit rate
<input type="radio"/> UBR	<ul style="list-style-type: none"> deterministic bit rate
<input type="radio"/> SBR	<ul style="list-style-type: none"> statistical bit rate
Direction type (b)	Available channels (forward / backward)
<input type="radio"/> Unidirectional ¹	<ul style="list-style-type: none"> unidirectional
<input type="radio"/> Bi-directional sym. ²	<ul style="list-style-type: none"> bidirectional (symmetrical)
<input type="radio"/> Bi-directional asym.	<ul style="list-style-type: none"> bidirectional (asymmetrical)
Connection type (c)	Available connection types
<input type="radio"/> Switched	<ul style="list-style-type: none"> switched virtual connections (SVC)
<input checked="" type="radio"/> Permanent	<ul style="list-style-type: none"> permanent virtual connection (PVC)
Channel type (d)	Available channel types
<input checked="" type="radio"/> Virtual channel	<ul style="list-style-type: none"> virtual channel
<input type="radio"/> Virtual path	<ul style="list-style-type: none"> virtual path (not yet supported)
AAL Type (e)³	Channel assignment to Adaptation Layer
<input checked="" type="radio"/> User defined	<ul style="list-style-type: none"> Setup message contains the information element “User defined AAL”.
<input type="radio"/> None	<ul style="list-style-type: none"> Setup message contains no AAL information element.
¹ For PVCs only ² Forward and backward parameters are identical (see “Traffic Contract”, “Traffic Contract (con’t)” and “Traffic Source” index cards) ³ Only with switched connections	

Table O-22 Radio buttons of the “General” index card



6.3.2 The “Header/Address” index card

This index card defines the default header values or the default ATM address of the selected channel, depending on whether a permanent (PVC) or a switched (SVC) channel is selected:

- PVC: Set default header
- SVC: Set default Called Party Address

You can overwrite the default values during configuration of the test type (in the “Test Setup” dialog) to match them to your measurement task.

Default Header

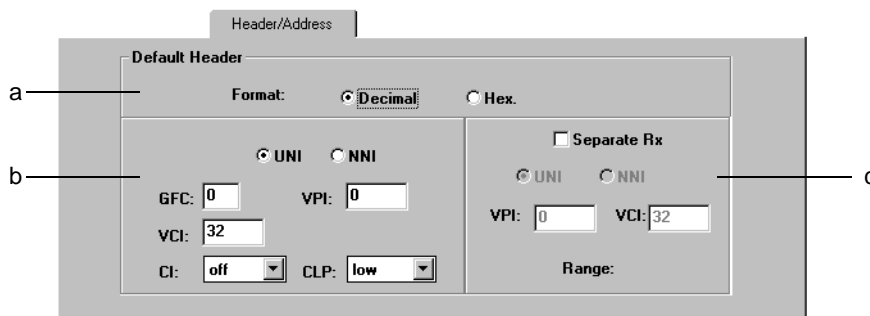

Fig. O-28 The “Header/Address” index card when using permanent virtual circuits: Default Header

The radio buttons and edit boxes have the following meanings:

Button/Box	Meaning
Format (a)	Radio buttons for selecting the VPI/VCI format.
Decimal	Tx and Rx numerical values entered and displayed as decimal numbers
Hex.	Tx and Rx numerical values entered and displayed as hexadecimal numbers
(b)	Tx (Rx) side header values
UNI/NNI	Input of interface type
GFC	Generic Flow Control (for UNI only)
VPI¹	Virtual Path Identifier
VCI¹	Virtual Channel Identifier
CI	Congestion Indicator
CLP	Cell Loss Priority (High = 1, Low = 0)
(c)	Rx side header values
Separate Rx	Check box for setting Rx side separately
UNI/NNI	Input of interface type
VPI¹	Virtual Path Identifier
VCI¹	Virtual Channel Identifier
Range	Range of values for GFC, VPI, VCI
1 If “Separate Rx” is not activated, the Tx values will be used	

Table O-23 Radio buttons and edit boxes of the “Header/Address” index card

Default Called Party Address

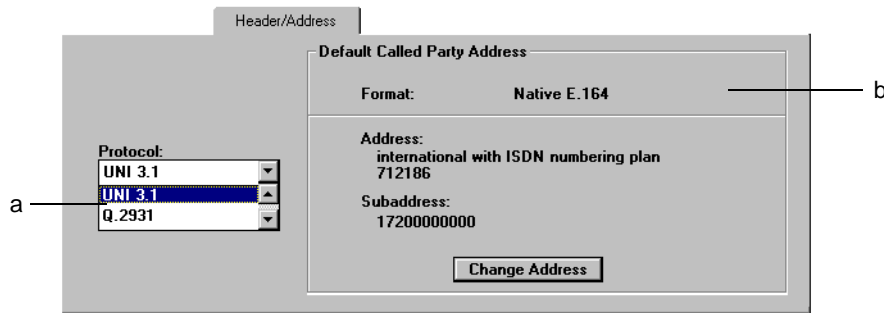

Fig. O-29 The “Header/Address” index card when using switched virtual circuits: Default Called Party Address

The sections have the following meanings:

Button/Box	Meaning
Protocol (a)	Combo box with protocol types UNI 3.0, UNI 3.1, Q.2931
Default Called Party Address (b)	Address display and action button for editing the default called party address of the channel.
Format	Format type display (e.g. Native E.164)
Address	Address display (various formats)
Subaddress	Sub-address display (if needed)
Change Address	Push button: Input address <ul style="list-style-type: none"> • for “Native E.164” format (Sec. 4.5.2, Page O-22) • for “NSAP” format (Sec. 4.5.2, Page O-22)

Table O-24 Display fields and other operating elements of the “Header/Address” index card

You can only assign a channel in the “Test Setup” dialog if the set signaling protocol is compatible with the actual instrument configuration; i.e. it is not possible to assign a channel defined for Q.2931 if the instrument is configured for UNI 3.1.



6.3.3 The “Traffic Contract” index card

This index card defines the channel traffic contract parameters. The possible entries depend on the selected traffic type. The index card contains the following sections:

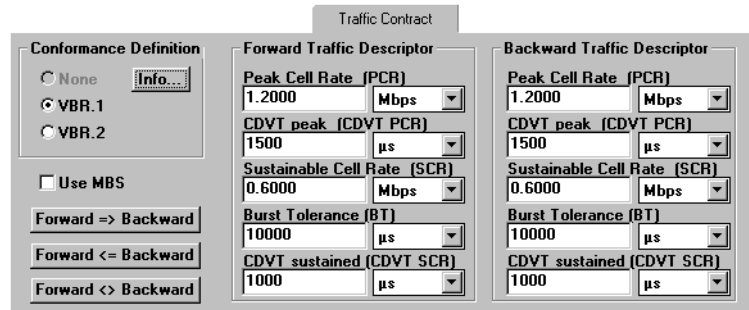

Fig. O-30 The “Traffic Contract” index card (Channel Editor)

The index card contains the following sections:

Section	Meaning
Conformance Definition:	Radio button for selecting the conformance definition
None ¹	- No conformance definition
CBR.1, VBR.1 ...	- Conformance definition, selection depends on traffic type
Info	- Information window for conformance definition
Use MBS	Activates / deactivates entry of maximum burst size parameter (in cells) instead of burst tolerance.
Forward/Backward Traffic Des.	Contract parameters for forward / backward direction
Peak Cell Rate	- Peak cell rate
CDVT peak	- Cell delay variation tolerance, referred to the peak cell rate
Sustainable Cell Rate ²	- Sustainable cell rate
Burst Tolerance ²	- Burst-tolerance
Maximum Burst Size ³	
CDVT sustained ²	- Cell delay variation tolerance, referred to the sustainable cell rate
Additional action buttons for bi-directional asymmetric channels ⁴	
Forward => Backward	Copies the forward parameters to the backward direction
Forward <= Backward	Copies the backward parameters to the forward direction
Forward<> Backward	Exchanges the forward and backward direction parameters
1 For PVC only (SVC always require conformance definition) 2 Not always available, depends on traffic type 3 This box is only available instead of “Burst Tolerance” if “Use MBS” is activated. 4 See “General” index card; the buttons only affect the relevant index card.	

Table O-25 Sections of the “Traffic Contract” index card (Channel Editor)

6.3.4 The “Traffic Contract” index card (continued)

This index card defines the extended part of the contract parameters for the channel. The possible entries depend on the selected connection type (PVC, SVC).

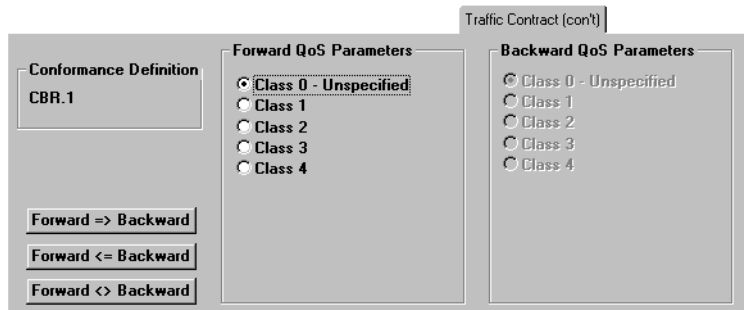

Fig. O-31 The “Traffic Contract (con’t)” index card (Channel Editor)

The index card contains the following sections:

Section	Meaning
Conformance Definition	
CBR.1	Display of selected conformance definition.
Forward/Backward QoS Parameters	
Quality of Service class for forward / backward direction	
Class 0 - Unspecified	Class 0: No quality of service specified
Class 1 ¹	Class 1
Class 2 ¹	Class 2
Class 3 ¹	Class 3
Class 4 ¹	Class 4
Additional action buttons for bi-directional asymmetric channels ²	
Forward => Backward	Copies the forward parameters to the backward direction
Forward <= Backward	Copies the backward parameters to the forward direction
Forward<> Backward	Exchanges the forward and backward direction parameters
¹ For SVC only ² See “General” index card; the buttons only affect the relevant index card	

Table O-26 Sections of the “Traffic Contract (con’t)” index card (Channel Editor)



6.3.5 The “Traffic Source” index card

This index card is used to set the default source parameters for the channel.

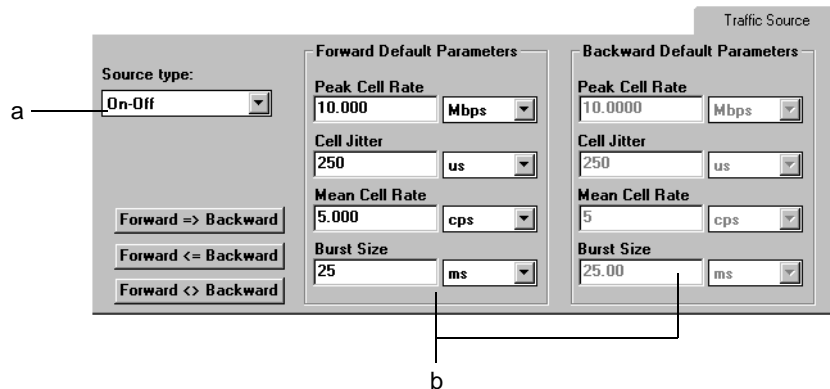

Fig. O-32 The “Traffic Source” index card (Channel Editor)

The index card contains the following sections:

Section	Meaning
Source type (a)	Source type
On-Off	- On / off source
Constant bit rate	- Constant bit rate source
Forward/Backward Default Parameters (b)	Source parameters for forward / backward direction
Peak Cell Rate	- Peak cell rate
Cell Jitter	- Cell delay variation tolerance, referred to the peak cell rate
Mean Cell Rate ¹	- Sustainable cell rate
Burst Size ¹	- Burst-tolerance
Additional action buttons for bi-directional asymmetric channels ²	
Forward => Backward	Copies the forward parameters to the backward direction
Forward <= Backward	Copies the backward parameters to the forward direction
Forward<> Backward	Exchanges the forward and backward direction parameters
¹ Not always available, depends on source type ² See “General” index card; the buttons only affect the relevant index card	

Table O-27 The sections of the “Traffic Source” index card (Channel Editor)



Notes:



Application Guide

1 The Application Manager

Starting point

The instrument has been started. After booting up, the “Application Manager” appears on the screen (“ANT20 - <Application Title>” window). The “Application Title” window is the central control for the instrument. It is used to control and manage the measurement applications and the results that they generate, and to control the measurement sequence. Remember that the various virtual instruments (VIs) can be selected and the desired maximum measurement time can be set from here.



Fig. A-1 The “ANT20 <Application Title>” window as “Minibar”

1.1 Selecting the Instruments for ATM Applications

An ATM application consists of at least the following VIs in addition to the “Signal Structure” VI:

- ATM Test Control and ATM Test Results, or
- ATM Channel Explorer, or
- all three of the above instruments.

The “Signal Structure” VI is needed for making interface settings or measurements on the physical layer (offset, level). It does not have to be saved along with the other VIs if this information is not required or if the interface characteristics do not need to be altered.



To select the instruments for your application

1. Click the above icon in the “Toolbar” of the Application Manager.
The “Add & Remove Instruments” dialog window opens.
2. Click on the check box(es) in the “Instrument group” section, which **no VI(s)** shall be loaded from. Consequently deactivate the “Physical Layer” (1) and “ATM Standard” (2) options for your ATM applications. The “Instruments available” list box will contain a reduced, more clearly arranged selection of “ATM Advanced” instruments.
3. Select the first VI (e.g. ATM Test Control) from the “Instruments available” list box.
4. Click the “Add>>” button.
The “ATM Test Control” VI is placed in the “Instruments used” list box.
5. Select the other VIs required as per steps 3 and 4.
6. Click the OK button.

The main windows of the three VIs are displayed on the screen and the corresponding buttons are displayed in the Application Manager (Minibar).



Fig. A-2 Application Manager after selection of VIs

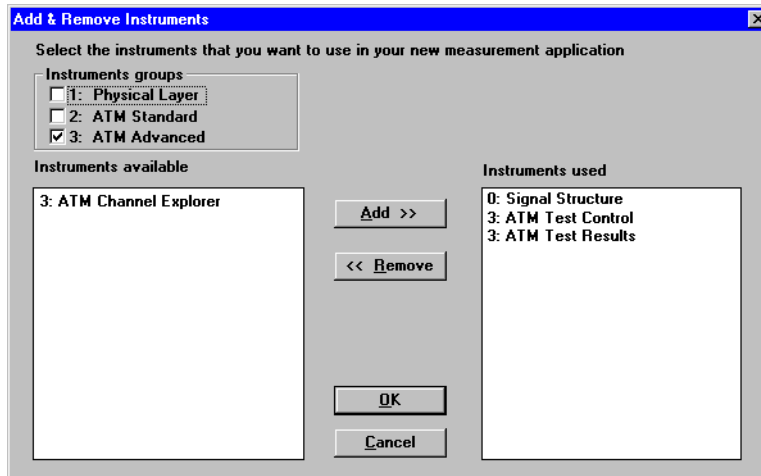

Fig. A-3 “Add & Remove Instruments” dialog after adding the desired virtual instruments (Preselection: ATM Advanced)

1.2 Starting and Stopping the Measurement



- ✓ Before starting the measurement, the traffic button in the Application Manager is set to “green”.

Starting the measurement

- ⇒ Click on the traffic signal button.
 - The measurement will be carried out with the parameters, set in the “Measurement Settings” dialog (Application manager)
 - The traffic button display will change from “green” to “red”
 - The status display will change from <Stopped> to <Running>.
 - The measurement will be stopped automatically after the Gate time run down. A measurement can also be stopped manually.



Stopping a measurement manually

- ⇒ Click on the traffic signal button again.
 - The measurement will be stopped.



2 ATM Layer Quality of Service Measurements (SVC)

2.1 Overview: Basic operating sequence

The following section lists all the necessary steps, from loading the application, basic configuration settings via defining the test traffic to the results display. Further information on the operating sequences is found in the corresponding sub-sections (see the “More” column). Please note the settings that apply to more than one VI. The VI icons used in the Application Manager are shown in the left-hand column as an aid to orientation.









VI	Operating step	More information
	1. Select the virtual instruments for the ATM application (ATM Test Control, ATM Test Results, Signal Structure)	Sec. 1.1, Page A-1
	2. Configure instrument Set topology, physical layer, ATM layer and, where appropriate, signaling. 3. Select test type 4. Configure test type Set test type, traffic type, source parameters, call address. 5. Enable/disable test traffic	Sec. 2.3.1, Page A-5 Sec. 2.3.2, Page A-9 Sec. 2.3.3, Page A-10 Sec. 2.4, Page A-12
	6. Prepare results recording <ul style="list-style-type: none"> Arrange results windows Activate Log-file if necessary 	Sec. 2.7.1, Page A-15
	7. Start measurement	Sec. 1.2, Page A-2
	8. Displaying and recording results “online” <ul style="list-style-type: none"> Signaling informations QoS Performance parameters Receiver status 	Sec. 2.7, Page A-15
	9. Change test parameters “on-line” Alter source parameters and observe effects in the “ATM Test Results” window. 10. Insert errors Insert errors and observe effects in the “ATM Test Results” window.	Sec. 2.5, Page A-13 Sec. 2.6, Page A-14
	11. Stop measurement	Sec. 1.2, Page A-2
	12. Final results <ul style="list-style-type: none"> evaluate store export print 	see “ATM Test Results” on-line help

Table A-1 Overview: ATM Layer Quality of Service Measurement (SVC)

2.2 Test setup and description

Chapter 2 takes you step by step through the procedure for ATM layer QoS tests. The procedure is based on a configuration with terminal emulation and signaling, to allow switched virtual connections (SVCs) to be tested. The example selection of an end-to-end measurement requires the use of a second instrument. The operating steps described apply to the left-hand instrument in “Calling” mode.

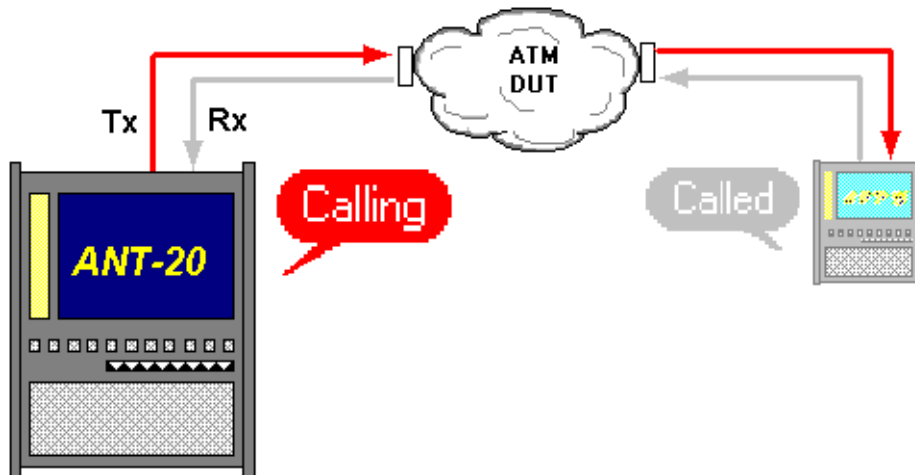

Fig. A-4 Test setup for switched point-to-point connection

2.3 Application settings

VIs required

- ATM Test Control
- ATM Test Results
- Signal Structure

⇒ Add the VIs required to the list of VIs used in the Application Manager.

The Application Manager should include at least the following instruments (see Fig. A-5):



Fig. A-5 “Application Manager” (Minibar) with ATM-Instruments



2.3.1 Configuring the Instrument: “ATM Test Control” VI

⇒ Click on the icon button of the “ATM Test Control” VI in the minibar (Application Manager) (see Fig. A-5).

The “ATM Test Control” main window appears on top (see Fig. A-6).

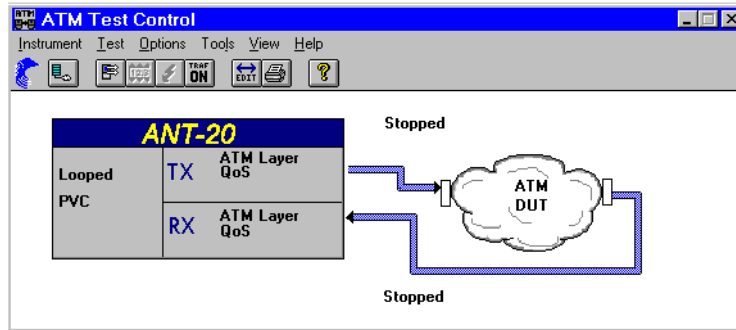

Fig. A-6 “ATM Test Control” main windows with last setting

The “ATM Test Control” VI is used to configure the instrument and to select a test type and its configuration (see Sec. 2.3.2).

The instrument configuration covers the selection of the connection configuration (topology), settings for the various protocol layers - in particular of the ATM and higher layers - and the selection of the connection type (“permanent” or “switched”).

To configure the instrument



⇒ Click this icon button

The “Instrument Configuration” dialog window opens.

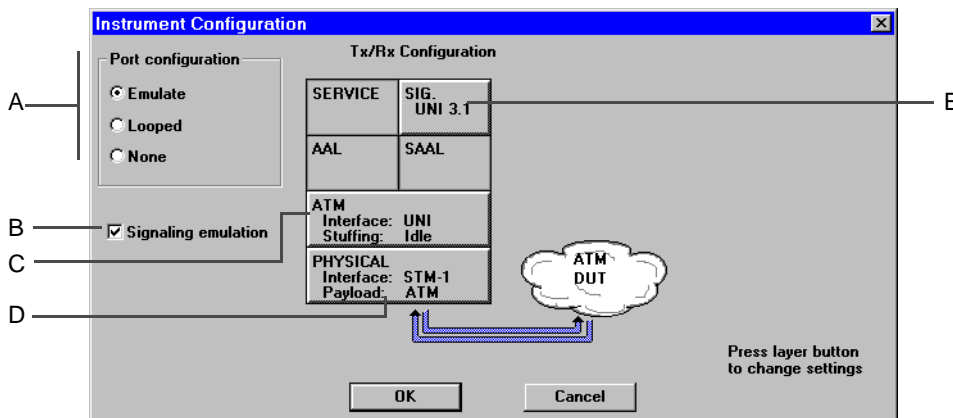

Fig. A-7 The “Instrument Configuration” dialog

A) To set the topology

⇒ Select the “Emulate” option in the “Port configuration” field to allow activation of signaling emulation.

“Emulate” can only be selected if the physical layer is set to the same bit rate and mapping for both generator and receiver; see D.

B) To enable signaling emulation

⇒ Check the “Signaling emulation” check box.
A check appears in the check box.

C) To configure the ATM layer

1. Click the “ATM” button.
The “Instrument Configuration - ATM Layer” dialog window opens.

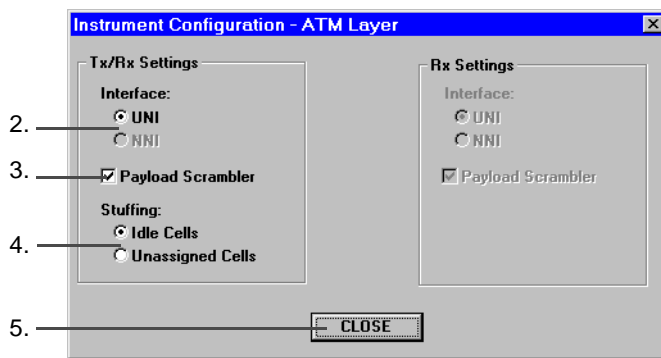

Fig. A-8 The “Instrument Configuration - ATM Layer” sub dialog

2. Select the interface corresponding to the actual measurement connection of the instrument by means of the “Interface” option buttons. If signaling is used, only the UNI interface type for terminal equipment is available.
3. Check the “Payload Scrambler” check box if the test cell payload is to be scrambled.
4. Select the type of justification cells using the “Stuffing” option buttons:
 - “Idle Cells” or “Unassigned Cells”.
5. Click the CLOSE button to confirm the configuration of the ATM layer; this returns you to the “Instrument Configuration” dialog.

D) To configure the physical layer: VI “Signal Structure”

Example: STM-1, C-4 mapping

✓ The “Instrument Configuration” dialog is open.

⇒ Click the “PHYSICAL” button.
The VI “Signal Structure” opens.

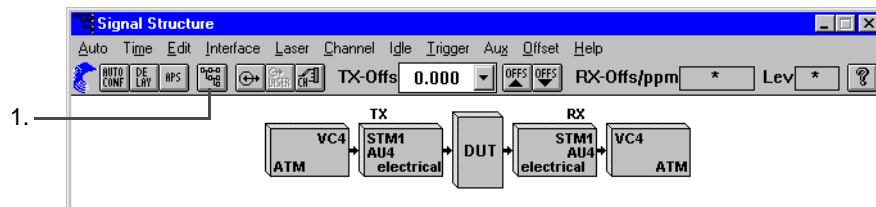

Fig. A-9 The “Signal Structure” main window



1. Click the toolbar icon or the “Edit - Signal Structure...” menu command
The “Edit Signal Structure” dialog window of the “Signal Structure” VI opens. The signal structure is set column by column using the corresponding buttons.

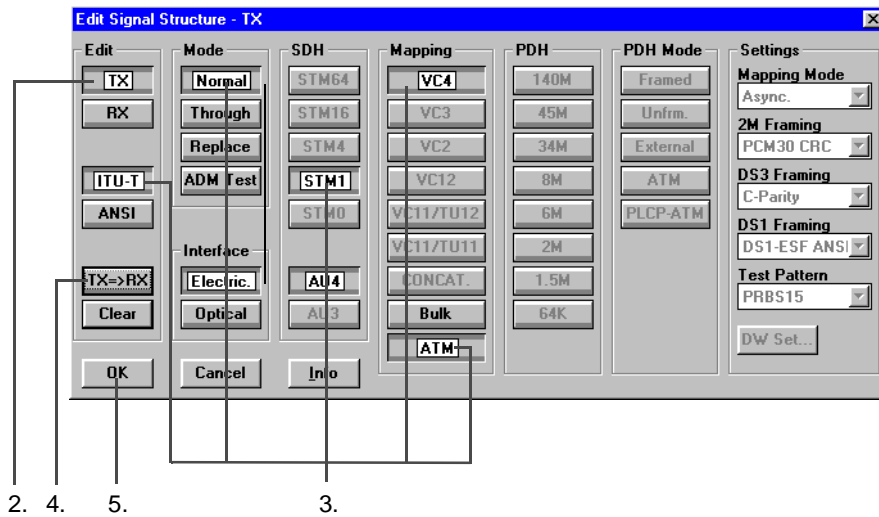

Fig. A-10 The “Signal Structure” window and “Edit Signal Structure - TX” dialog

2. Click the “TX” button to configure the transmitting side.
3. Set the signal structure, e.g. “ITU-T”, “Normal”, “STM-1”, “AU4”, “VC4” and “ATM” by clicking the appropriate buttons.
4. Click the “TX=>RX” button.
This sets the receiving side to the same settings as the transmitting side.
5. Confirm the input by clicking “OK”. this returns you to the “Instrument Configuration” dialog.

E) To configure the signaling

- ✓ The “Instrument Configuration” dialog is open.

1. Click the “SIG” button.
The “Instrument Configuration - Signaling Protocol” dialog window opens.

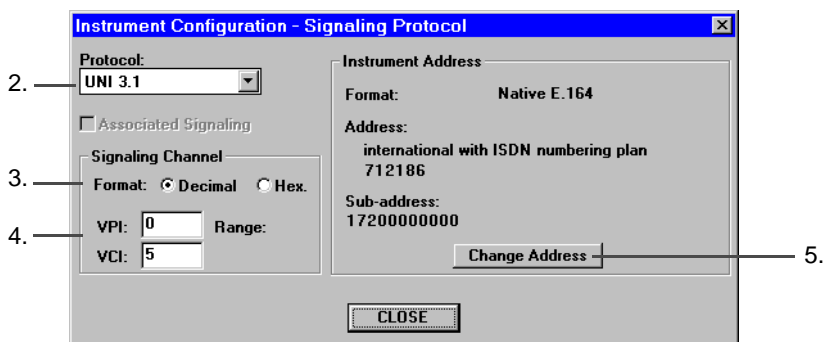

Fig. A-11 The “Instrument Configuration - Signaling Protocol” sub dialog

2. Select the required item, e.g. “Q.2931” in the “Protocol” list box.
3. Select the input format, e.g. “Decimal” using the option buttons.
4. Edit the VPI and VCI values in the entry boxes.
The available range is shown under “Range”.

Option “Change own address”

- Click the “Change Address” button if you want to alter the address of the instrument.
The “Address Input” dialog window opens.

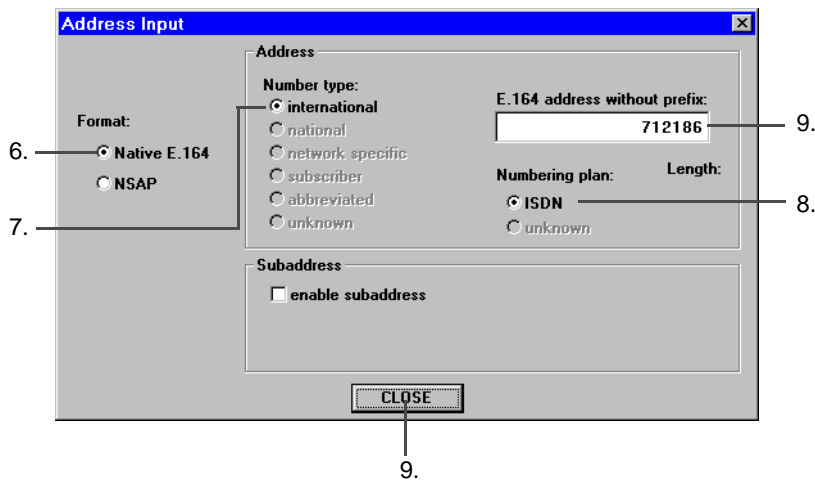

Fig. A-12 The “Address Input” dialog

- Select the address format, e.g. Native E.164.
- Select the type of code number, e.g. International.
- Select the type of numbering plan, e.g. ISDN.
- Set the address or dialling number (without 0 prefix).
The maximum number of digits is shown under “Length”.
- Click the CLOSE button to confirm the address.
This returns you to the “Signaling Protocol” or “Instrument Configuration” window.



2.3.2 Selecting the Test Type: “ATM Test Control” VI

The “Test types” available for selection are used to structure the measurement and connection types or so-called “Connection modes”. They are arranged according to protocol layers, with only the ATM layer currently supported. Only those test types that are possible and meaningful for the selected instrument configuration are available for selection.

To select and configure the test type required for your measurement task

- ✓ The instrument is configured for Emulate topology with switched virtual connections (SVCs).
- ✓ The “ATM Test Control” main window is open.



⇒ Click on this icon button or select the “Test - Setup...” menu command.
The “Test Setup” dialog window opens.

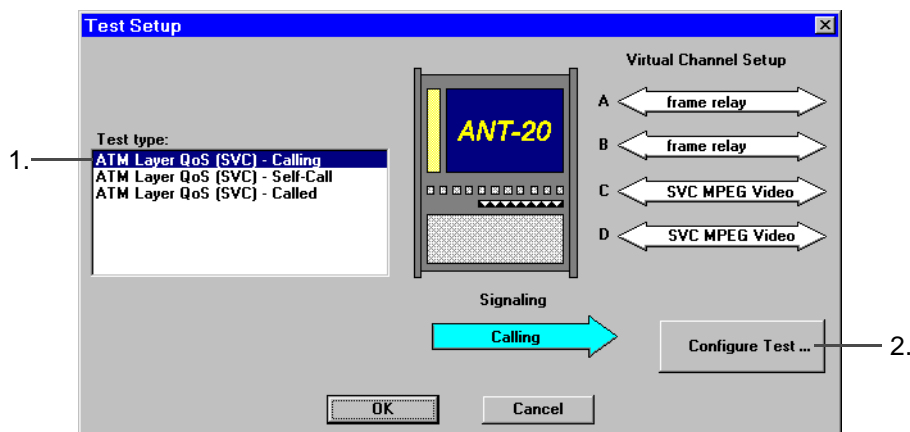

Fig. A-13 The “Test Setup” dialog

1. Select the desired test type from the “Test type” list box, e.g. “ATM Layer QoS (SVC) - Calling”
2. Click the “Configure Test” button.
The “Test Setup <...>” dialog window opens (see Sec. 2.3.3).
– or –
Click the OK button if the pre-defined test type is to be used.
This returns you to the main window.

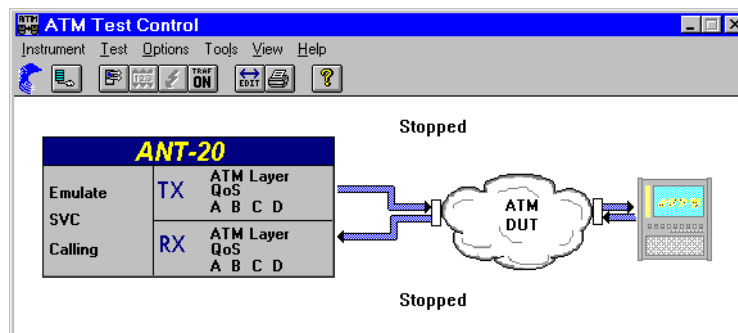

Fig. A-14 The “ATM Test Control” main window

2.3.3 Configuring the Test Type: “ATM Test Control” VI

To configure the test type required for your measurement task

- ✓ The “Test Setup” dialog window is open.
- ⇒ Click the “Configure Test” button.
- The “Test Setup <...>” dialog window opens.

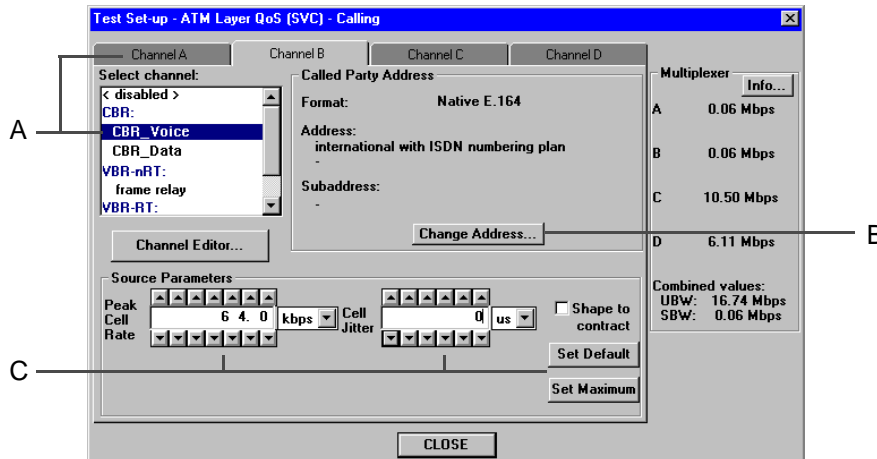

Fig. A-15 The “Test Setup - ATM Layer Qos (SVC) - Calling” dialog

A) To assign virtual channels to your test type

- ✓ The first index card for “Channel A” has been selected
1. In the “Select channel” list, mark the virtual channel that you want to assign to the *first* test channel: e.g. with the designation “CBR_Voice” (constant bit rate voice traffic). The corresponding parameter values are shown on the index card.
 2. Click on the index card for the *second* channel, e.g. “Channel B”. The index card moves to the front.
 3. In the “Select channel” list, select the virtual channel that you want to assign to the second test channel e.g. with the designation “CBR_Data” (constant bit rate data traffic). The corresponding parameter values are shown on the index card.

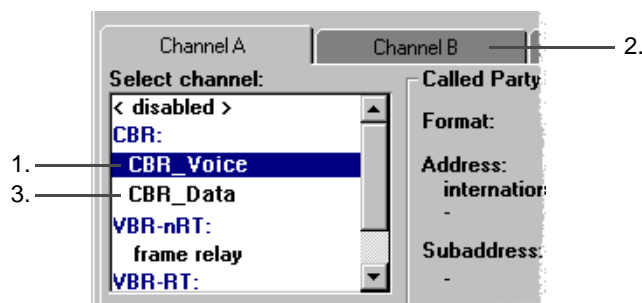

Fig. A-16 Assigning virtual channels to your test type

Note:

- The “Select channel” list contains just a few standard channels when it is first opened.
- Virtual channels can be used more than once, i.e. on more than one index card.



B) Entering the address of the called instrument

- ✓ The “Test - Setup <...>” dialog is open.
- ✓ The instrument is configured for SVCs.

1. Click the “Change Address” button.
The “Address Input” dialog window opens.

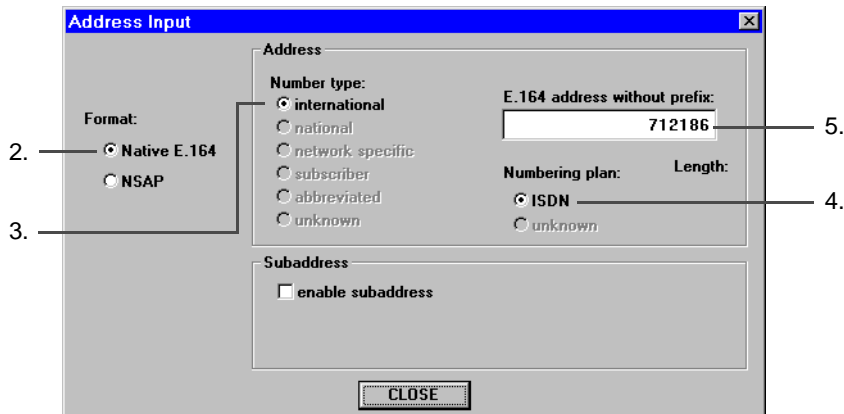

Fig. A-17 The “Address Input” dialog

2. Select the address format, e.g. Native E.164.
3. Select the type of code number, e.g. International.
4. Select the type of numbering plan, e.g. ISDN.
5. Set the address or dialling number (without 0 prefix).
The maximum number of digits is shown under “Length”.
6. Click the CLOSE button to confirm the address.
This returns you to the “Test - Setup <...>” window.

C) Changing the source parameters, e.g. Peak Cell Rate

- a) Click the arrow key to increase the parameter value in decades.
– or –
- b) Click the arrow key to decrease the parameter value in decades.
- c) Open the list box if the units are to be changed, and select the appropriate list entry (e.g. kbps).

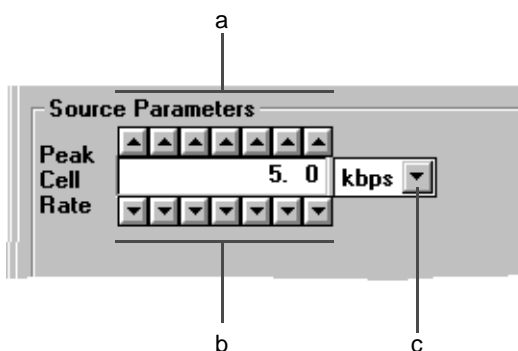

Fig. A-18 Changing the source parameter

Removing a test channel, if necessary

1. Click on the index card of the channel that you want to remove, e.g. "Channel B".
The index card showing the current channel and traffic type will move to the front.
2. Click on "<disabled>" in the "Select channel" list.
"Channel B" will be removed from the current test traffic.

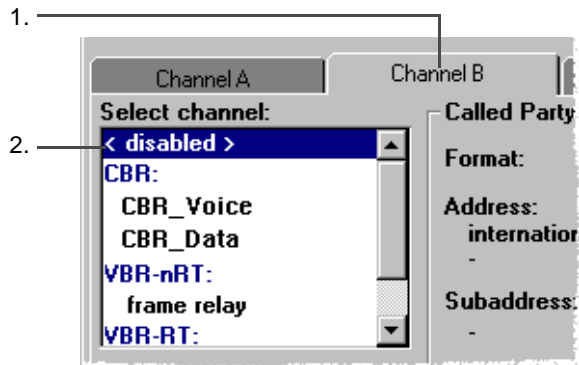

Fig. A-19 Removing test channel

2.4 Enabling and Disabling Test Traffic: "ATM Test Control" VI

- ✓ The "ATM Test Control" main window is open.



To enable the test cell stream

- ⇒ Click the above icon in the "Toolbar".
- or –
- ⇒ Select the "Test - Traffic Enable" menu command.
Test traffic will be enabled.

To disable the test cell stream

- ⇒ Click the above icon in the "Toolbar" again.
- or –
- ⇒ Select the "Test - Traffic Enable" menu command again.
Test traffic will be disabled.

- Note:** Test traffic:
- For SVC: Only after the connection is set up
 - For PVC: Immediately after clicking the "TRAF ON" button.



2.5 Editing Test Parameters “On-Line”: “ATM Test Control” VI



Opening the “Online Control” dialog window

- ✓ The “ATM Test Control” main window is open.
- ⇒ Click the above icon button of the toolbar.
– or –
- ⇒ Select the “Test - Online Control” menu command.
The “Test Online Control - ATM Quality of Service...” dialog window opens.
The source parameters which can be altered during traffic generation can be accessed and can be edited channel by channel: “Peak Cell Rate”, “Mean Cell Rate”, “Cell Jitter” and “Burst Size”.

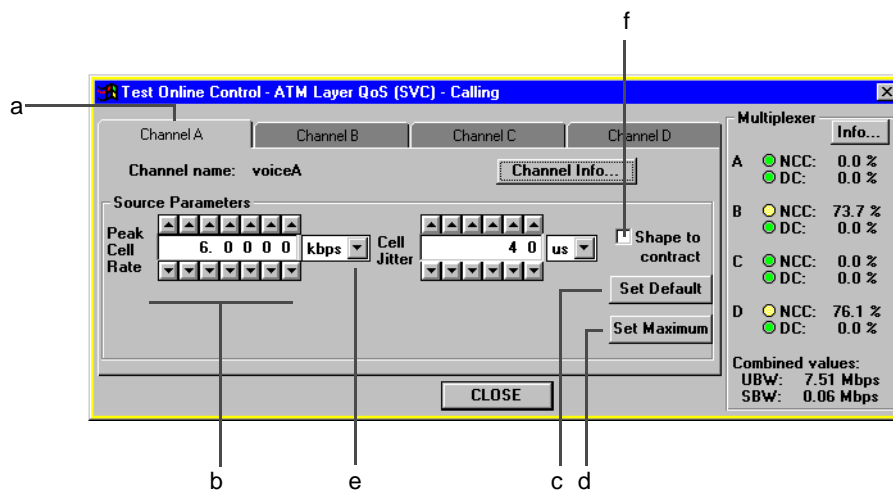

Fig. A-20 “Test Online Control” dialog, eg. for test type “ATM Quality of Service ATM Layer QoS (SVC) - Calling”

- a) Click on the index tab of the virtual channel required (e.g. Channel A ...).
The test parameters for the channel are placed on top.
- b) Change the parameter (e.g. Peak Cell Rate) continuously using the arrow keys.
– or –
- c) Set the default parameter value by clicking the “Set Default” button.
– or –
- d) Set the maximum parameter value by clicking the “Set Maximum” button.
- e) Open the list box if the units are to be changed, and select the appropriate list entry (e.g. kbps).
- f) Activate the “Shape to contract” check box if the Traffic Shaper is to be activated.

2.6 Inserting Errors: “ATM Test Control” VI



Opening the “Error Insertion” dialog window

- ✓ The “ATM Test Control” main window is open.
- ⇒ Click the above icon button of the toolbar.
– or –
- ⇒ Select the “Test - Error Insertion” menu command.
The “Test Error Insertion ATM Quality of Service” window opens.
The error criteria required for the measurement task can be inserted in each test channel separately.

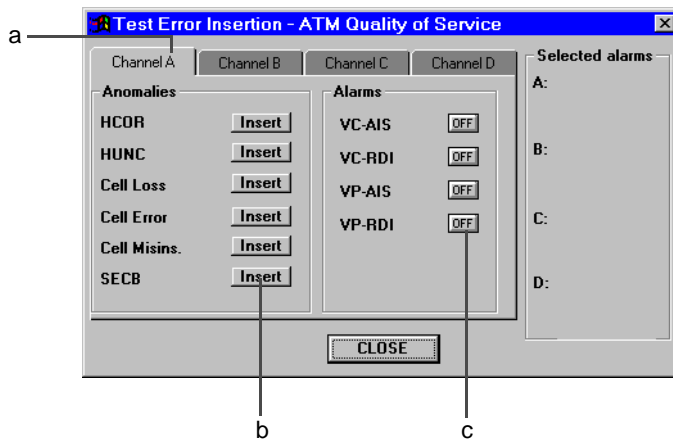

Fig. A-21 The “Test Error Insertion” dialog for ATM Quality of Service

- a) Click on the tab index for the virtual channel required (e.g. Channel A ...).
The action buttons for the various error types are placed on top.
- b) Insert an **anomaly** (e.g. “Severely Errored Cell Block) by clicking the “Insert” button (next to “SECB”).
Each time the button is clicked, the anomaly will be inserted into the test cell stream.
- c) Insert an **alarm** (e.g. “Virtual Path Remote Defect Indication”) by clicking the “OFF” button (next to “VP-RDI”).
The alarm criterion is now set for the virtual channel and the button label changes from OFF to ON (toggle function). Also, all alarms set for the channels are listed in the “Selected alarms” box.
The alarm remains set until the test cell stream is switched off or the “ON” button is clicked to turn the alarm OFF.



2.7 Displaying the Results: “ATM Test Results” VI



Fig. A-22 Application manager

⇒ Click the icon button for the “ATM Test Results” VI in the minibar.
The “Test Results” window is displayed on top.

After the VI has booted up, the work area contains the following results windows:

- **Receiver Status:** This window indicates the receiver status
- **Quality of Service:** This window indicates the QoS performance parameters as per ITU-T O.191. The results are displayed for up to four test channels: Cell Error Ratio, Cell Loss Ratio, Cell Misinsertion Rate, Mean Cell Transfer Delay, etc.
- **Signaling Analysis:** This window indicates the results of signaling analysis.

2.7.1 Preparing to Record Results



Arranging the results windows for the application

Normally, the three results windows are displayed in a space-saving cascade arrangement. This arrangement can be altered as required and restored at any time.

- ⇒ Click the above icon button of the toolbar.
– or –
⇒ Select the “View - Cascade” menu command.
The three results windows are displayed in the default arrangement.

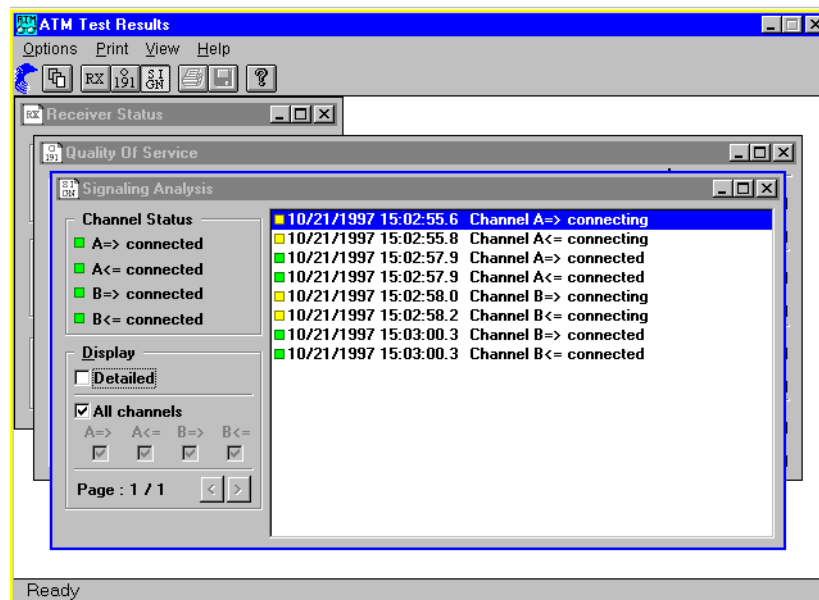

Fig. A-23 Results window “Signaling Analysis”



The “Signaling Analysis” is on top when the configuration selected is for switched virtual connections (SVC). This allows you to follow the signaling sequence right from when the call is being set up. The window is not displayed for configurations with permanent virtual connections (PVC) since it has no meaning in this context.

After the measurement is started (Sec. 1.2, Page A-2), all data events are written continuously as they occur to the display fields of the windows. The “Print” menu commands can be used once the measurement has ended to print out the data or export it for further processing with other programs.

2.7.2 Displaying the Signaling Analysis

For each measurement involving switched virtual connections (SVC), a record of the signaling is made and is displayed in the “Signaling Analysis” window. This record is also saved as a log file. If the “Log QoS Parameters” option is activated, the QoS parameter results will also be saved in the log file when the connection is cleared down. This permits the making of a complete record for measurements of test types “ATM Layer QoS (SVC) <...>”. This is particularly useful when an instrument in “Called” mode is operated without supervision over a long period of time.



Putting the “Signaling Analysis” window on top

(where this is not already the case)

- ⇒ Click the above icon button of the toolbar.
 - or –
- ⇒ Select the “View - Signaling Analyzer” menu command.
The “Signaling Analysis” window is displayed on top.

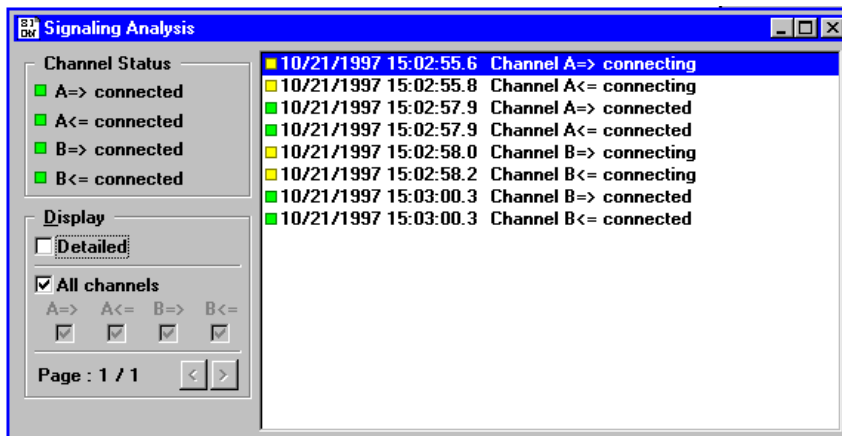

Fig. A-24 The “Signaling Analysis” results window



Channel Status

The "Channel Status" field indicates the circuit status of the test channels:

Red	"disconnected"	Circuit disconnected.
Yellow	"connecting"	Circuit in process of connecting.
Green	"connected"	Circuit connected (switched).

Signaling events

This display field indicates the progress of the signaling. The signaling events are shown consecutively in separate lines, each with date and time information. Each time there is a change in the status of the channel circuit, this is indicated in the display field. A channel can assume any of the following states:

disconnected	Circuit disconnected
connecting	Circuit in process of connecting
connected	Circuit connected (switched)

If the "Detailed" check box is marked, additional information will be shown for each change of status.

for "disconnected": Indication of reason for disconnection

for "connecting": Address of called instrument and traffic contract parameters (for called instrument only)

for "connected": VPI/VCI values for the switched test channel and the call set up time (for calling instrument only)

Display

The "Display" field allows you to select the signaling information to be displayed in the right-hand display field and to control the display itself. The following check boxes and action buttons are provided:

Detailed	Check box for selecting the degree of detail in the displayed information:
"Detailed" off:	Display of circuit status only (e.g. connected)
"Detailed" on:	Display of additional information. If the "Log QoS Parameters" is selected, the measured QoS parameters will also be displayed
All channels	Check box for displaying all channels
A, B, ...	Check box for displaying a specific test channel
Page:	Display of the displayed page number and the total number of pages
<	Action button for paging backwards
>	Action button for paging forwards



2.7.3 The “Quality Of Service” window

The “Quality Of Service” results window shows the ITU-T O.191 QoS performance parameters. The index cards of the window show detailed, channel-specific results. The right-hand section of the window is always visible and shows the alarm states for all channels.

The VI displays the QoS performance parameters of up to four permanent virtual circuits (PVC) or switched virtual circuits (SVC) simultaneously. The index cards are labeled according to the active test type. These are explained below under “Explanation”.



Putting the “Quality Of Service” window on top

⇒ Click the above icon button of the toolbar.

– or –

⇒ Select the “View - Quality Of Service” menu command.

The “Quality Of Service” window is displayed on top with the QoS parameters (left section) and possible alarm events (right section).

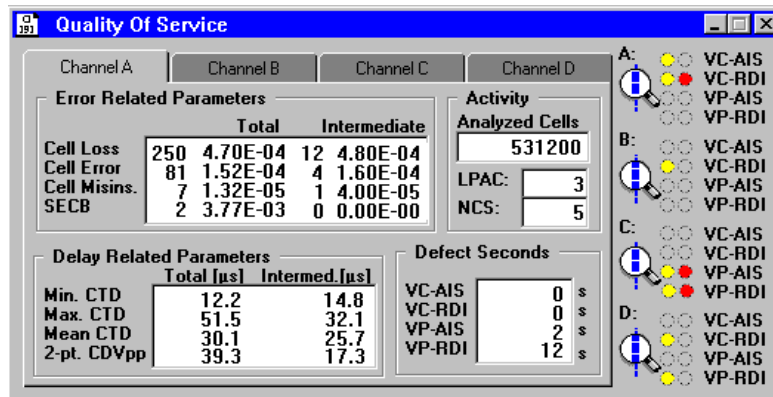

Fig. A-25 The “Quality Of Service” results window

QoS-Parameter

Error Related Parameters

The “Error Related Parameters” display field shows the performance parameters indicating communication errors for the selected test channel.

Cell Loss	Lost cells
Cell Error	Errored cells
Cell Misins.	Misinserted cells
SECB	Severely Errored Cell Blocks

The two leftmost columns show the “Total” results. The two rightmost columns show the “Intermediate” results. The Total results are for the entire measurement period up to this point. The Intermediate results are those for the last intermediate interval. The length of the intermediate interval can be set in the Application Manager. The absolute value (Count) and the Rate or Ratio are displayed for each parameter.



Delay Related Parameters

The “Delay Related Parameters” display field shows the performance parameters affecting the cell transfer delay for the selected test channel. The overall results are shown under “Total”. The intermediate results are shown under “Intermed.” The Total results are for the entire measurement period up to this point. The Intermediate results are those for the last intermediate interval. The length of the intermediate interval can be set in the Application Manager.

Min. CTD	Minimum cell transfer delay
Max. CTD	Maximum cell transfer delay
Mean CTD	Mean cell transfer delay
2-pt. CDVpp	2-point cell delay variation

Activity

The “Activity” display field shows additional information about the performance of the analyzed channel:

Analyzed Cells	Number of cells analyzed. The greater the number of cells evaluated, the more reliable the values measured for the error- and delay-related parameters
LPAC	Indication of “Defect Seconds” for which no performance parameters could be measured (Loss of Performance Assessment Capability). This can be due to an alarm in the physical layer, for example. LPAC is a measure of the availability of the circuit. Each LPAC second is non-available time.
NCS	Indication of “Defect Seconds” for which the test channel is not connected (Not Connected Seconds). This indication is only relevant for switched virtual circuits (SVC)..

Defect Seconds (QoS-Parameter)

The “Defect Seconds” display field shows the defect seconds for the following defects:

VP-AIS	Virtual Path Alarm Indication Signal (F4 layer)
VP-RDI	Virtual Path Remote Defect Indication (F4 layer)
VC-AIS	Virtual Channel Alarm Indication Signal (F5 layer)
VC-RDI	Virtual Channel Remote Defect Indication (F5 layer)

Alarms

Alarms that have occurred (defects) are indicated by a set of LEDs for all test channels together.

Yellow	“History”: On if the alarm occurred at least once during the entire measurement interval.
Yellow and red	“Current”: On when the alarm is active.



The alarm duration is shown separately for each channel on the corresponding index cards.

- The “Delay Related Parameters” are only displayed if one of the following test types was selected in the “ATM Test Control” VI:
 - ATM Layer QoS - Looped Topology, or
 - ATM Layer QoS (PVC) - Looped, or
 - ATM Layer QoS (SVC)- Self-Call
- The call set-up times are not shown in the “Quality Of Service” window. They are displayed in the “Signaling Analysis” window.

2.7.4 The “Receiver Status” window

The “Receiver Status” results window gives a quick overview of the status of the receiver. This window is always displayed in the workspace, regardless of the current type of test.



Putting the “Receiver Status” window on top

- ⇒ Click the above icon button of the toolbar.
 - or –
- ⇒ Select the “View - Receiver Status” menu command.
 - The “Receiver Status” window is displayed on to.

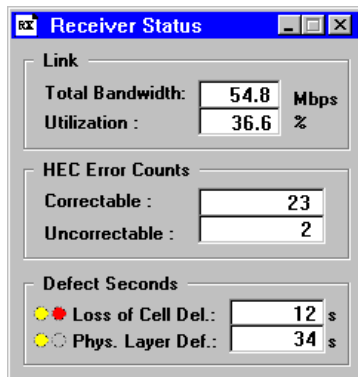

Fig. A-26 The “Receiver Status” results window

Link

The “Link” display field shows information about the total load on the physical link. The load is calculated over all virtual channels, regardless of the test channels that are set. The actual load is averaged at intervals of 0.1 second.

Total Bandwidth in Mbps
Utilization in %



HEC Error Counts

The “HEC Error Counts” display area shows the results of the receiver Header Error Check. The values are cumulative for the entire measurement interval.

Correctable	Total number of correctable header errors
Uncorrectable	Total number of uncorrectable header errors

Defect Seconds

The “Defect Seconds” display field registers the defects (alarms) in the physical layer:

Loss of Cell Del.	Loss of Cell Delineation
Phys. Layer Def.	Physical Layer Defect. Alarm occurring as a result of an interruption in the data stream in the physical layer.

The alarm status is shown by LEDs and the alarm duration is shown under “Defect Seconds”.

Yellow	“History”: On if the alarm occurred at least once during the entire measurement interval.
Yellow and red	“Current”: On when the alarm is active.



3 Detecting and analyzing ATM channels (Channel Explorer)

3.1 Overview: Basic operating sequence

The following section lists all the necessary steps, from starting the application and selecting the scan type through to the scan itself and on to sorting the results and recording them. Further information on the operating sequences is found in the corresponding sub-sections (see the “More” column). Please note the settings that apply to more than one VI. The VI icons used in the “minibar” are shown in the left-hand column as an aid to orientation.





VI	Operating step	More information
	1. Select the virtual instruments for the ATM application “Signal Structure” VI and “ATM Channel Explorer” VI	Sec. 1.1, Page A-1
	2. Set the signal structure Configure the physical layer and match it to the measurement task	see D on page A-6
	3. Close the “Signal Structure” VI	-
	4. Select the scan type <ul style="list-style-type: none"> Select the “Activity” scan if active traffic channels are to be displayed – or – Select the “Trouble” scan type if channels showing alarms are to be displayed. 5. Select the options <ul style="list-style-type: none"> Select the interface at which the measurement is being made. Deselect the inactive channels. 6. Trigger the scan The traffic check or alarm detection procedure starts. The required channels are entered one after the other in the results window. The scan runs until the 1000th channel is detected or until the scan is stopped.	Sec. 3.4.1, Page A-24 Sec. 3.4.4, Page A-27
	7. Perform AAL analysis (“Activity” scan type) <ul style="list-style-type: none"> Select “AAL Type” analysis if you want a tabular evaluation according to AAL types. – or – Select “AAL Type Distribution” analysis if you want a graphical evaluation according to AAL types. 	Sec. 3.4.2, Page A-25 Sec. 3.4.3, Page A-26
	8. Sort the channels 9. Record and/or further process the results <ul style="list-style-type: none"> Print out the contents of the results window – or – Export the contents of the results window. 	Sec. 3.6, Page A-30 see “Channel Explorer” on-line help

Table A-2 Overview: Detecting and analyzing ATM channels



3.2 Test setup and description

Chapter 3 describes the procedure for checking traffic and locating faults using the “Channel Explorer”. This tool is used to interactively observe the events on an ATM link and to analyze them. The various “Scan and analysis types” available are described.

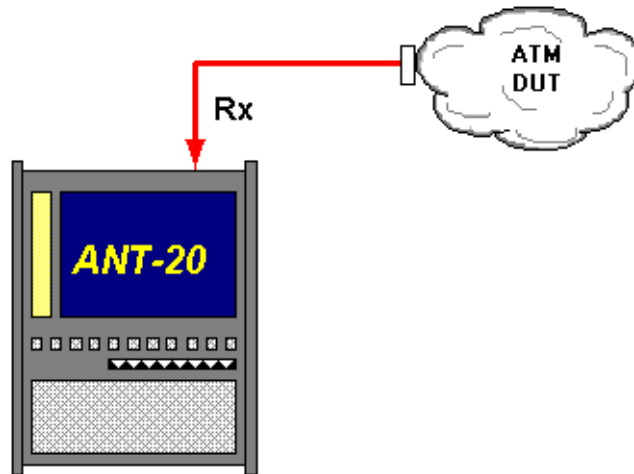

Fig. A-27 Test setup for traffic checking

3.3 Application settings

VIs required

- ATM Channel Explorer
- Signal Structure

⇒ Add the VIs required to the list of VIs used in the Application Manager.

The Application Manager should include at least the following instruments (see Fig. A-28):



Fig. A-28 Minibar (Application Manager) after selecting the VIs



3.4 Measurement

3.4.1 "Activity" Scan: Detect and Display Active ATM Channels

"Scan - Activity" looks for active channels. The instrument detects every active channel and enters it in to the results list. The "Activity" scan type is the default setting, as shown in the header of the current results list.

⇒ Click on the icon button of the "ATM Channel Explorer" VI in the minibar (Application Manager).

The "ATM Channel Explorer" main window appears on top.

To select "Activity" scan if this is not activated by default

The scan type is set and the scan is controlled from the "Scan" menu.

⇒ Click the item "Activity" in the "Scan" menu.

The selected function is marked with a dot.

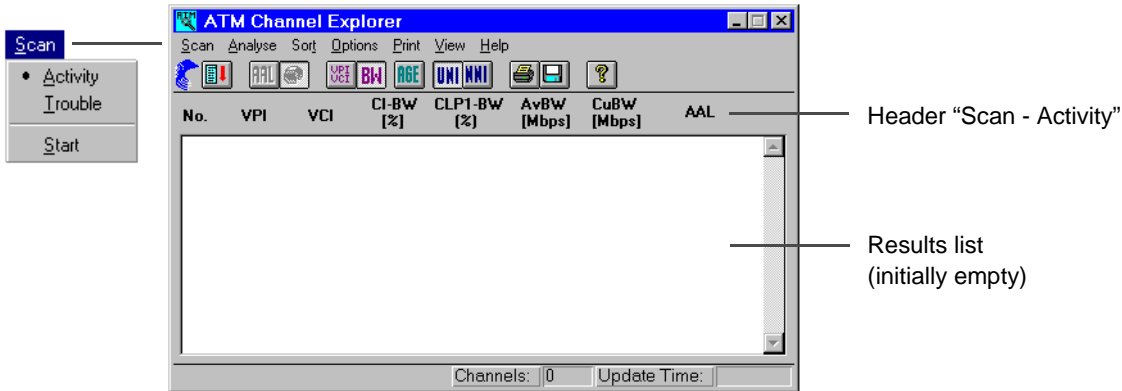

Fig. A-29 The "Scan" menu with selected "Activity" scan type and corresponding results list



To start the scan

⇒ Click the above icon button of the toolbar or click "Start" in the "Scan" menu.

The scan starts. Channels detected are entered successively in the corresponding results windows.

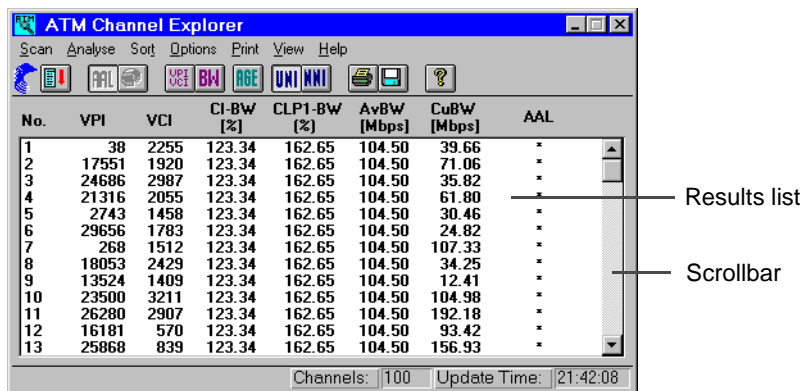

Fig. A-30 The "ATM Channel Explorer" with detected channels



Tip: To stop the scan click the icon button of the toolbar again or click “Start” in the “Scan” menu again.

A scan can only be started or a test traffic can be generated, when no other measurements that are started from the Application Manager are in progress. No other measurements can be started or a test traffic can be generated, while a scan is in progress.

Column	Meaning
No.	Sequence number to assist orientation in the list
VPI	Virtual Path Identifier. Displayed as a decimal number.
VCI	Virtual Channel Identifier. Displayed as a decimal number.
CI-BW	Congestion Indicator Bandwidth: Proportion of cells with Congestion Indication (CI) bit set. The displayed percentage is determined over the entire duration of the scan.
CLP1-BW	Cell Loss Priority 1 Bandwidth: Proportion of cells with Cell Loss Priority (CLP) bit set. The displayed percentage is determined over the entire duration of the scan.
AvBW	Average Bandwidth of the channel in Mbit/s. The displayed value is determined over the entire duration of the scan. All user and OAM cells are included in the calculation.
CuBW	Current Bandwidth or channel load in Mbit/s. The displayed value is the average for the last seconds. All user and OAM cells are included in the calculation.

Table A-3 Result list header for “Activity” scan type

3.4.2 Analyzing the AAL types of active ATM channels

Detect and analyze the AAL types in the detected ATM channels (Fig. A-30, Page A-24).



To start the analysis

⇒ Click the above icon button of the toolbar or click the item “AAL Type” in the “Analyse” menu. A bargraph display appears indicating the progress of the analysis.

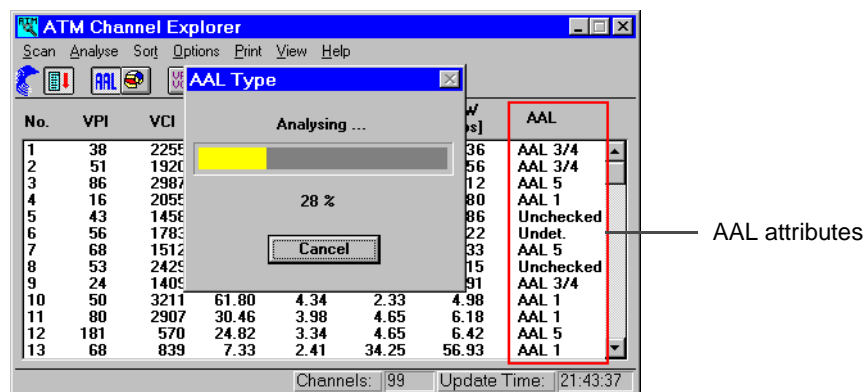

Fig. A-31 Analysis of AAL types

If a large number of channels are listed in the results window, AAL analysis may take a very long time. You can interrupt the analysis at any time using the “Cancel” button. All the channels listed, regardless of AAL status, are checked during an AAL analysis.



To stop the analysis

- ⇒ Click the “Cancel” button (e.g. if “Unchecked” entries appear in the list).
- or –
- The analysis stops automatically when all channels are analyzed again.

Attribute	Meaning
AAL 1	Constant bit rate channel (AAL type 1, service class A)
AAL 3/4	Data services channel (AAL type 3/4, service class C, D)
AAL 5	Channel with simplified protocol for rapid data communications (AAL type 5, service class C)
Unchecked	The channel was not checked for AAL type. Reason: User aborted analysis.
Undet.	Channel cannot be analyzed or assigned to a particular AAL type. Reason: unknown AAL type or no activity in channel.

Table A-4 AAL type display after an AAL analysis

3.4.3 Displaying the AAL Type Distribution

Determine and display the distribution of active ATM channels according to AAL types.



To start the analysis

- ⇒ Click the above icon button of the toolbar or click the item “AAL Type Distribution” in the “Analyse” menu.
- The “AAL Type Distribution” window showing the current distribution of active channels according to AAL types is displayed.
- The pie chart gives a dynamic overview
- The table lists percentage values to give a quantitative display

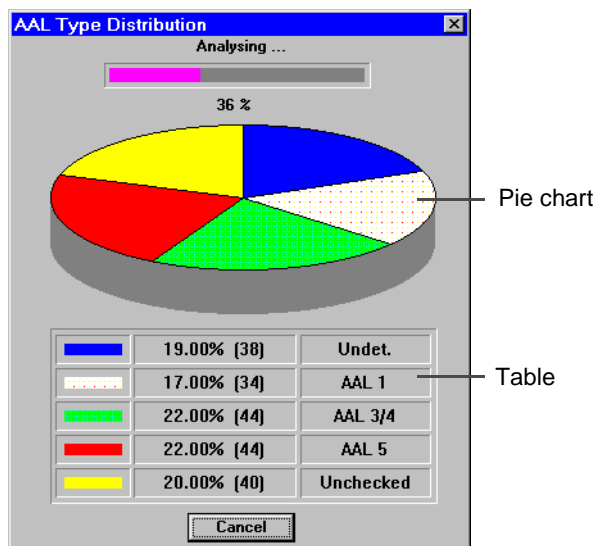

Fig. A-32 AAL type analysis



To stop the analysis

⇒ Click the “Cancel” button.

– or –

The analysis stops automatically when the analysis is complete (“Unchecked” = 0%).

When you perform an “AAL Type Distribution” analysis, an “AAL Type” analysis is automatically also performed.

- If a large number of channels are listed in the results window, AAL analysis may take a very long time. You can interrupt the analysis at any time using the “Cancel” button.
- If the analysis is aborted, the distribution of the channels analyzed so far will be displayed.

Pie chart

Graphic display of distribution according to AAL types. The yellow segment indicates the as yet unchecked channels. It decreases in size as the analysis progresses.

Table

Color	Load (example)	Number of channels	Meaning
blue	19.00 %	38	Channels cannot be analyzed or cannot be assigned to an AAL type. Cause: Unknown AAL type or channel currently inactive.
white	17.00 %	34	Channel with AAL type 1
green	22.00 %	44	Channel with AAL type 3/4
red	22.00 %	44	Channel with AAL type 5
yellow	20.00 %	40	Channels not yet checked for AAL type.

Tabelle E-5 Column meanings (Example: Analysis of 200 channels)

“Cancel” button

Cancels the analysis as long as a yellow segment is visible or “Unchecked” > 0 %. The analysis ends when the yellow segment disappears or “Unchecked” = 0 % and the “Cancel” button changes to “OK”.

3.4.4 Trouble Scan: Detecting and displaying ATM Channels where alarms are present

“Scan - Trouble” searches for channels that exhibit an alarm state. The instrument detects every alarm indication cell and enters the corresponding channel into the results list. There are two results windows corresponding to the error management hierarchy:

- F4 window: OAM Flow 4 (VP layer)
- F5 window: OAM Flow 5 (VC layer)

The type of record and the scan type are set and the scan is controlled from the “Scan” menu.



To select "Trouble" scan

⇒ Click the item "Trouble" in the "Scan" menu.
The selected function is marked with a dot.

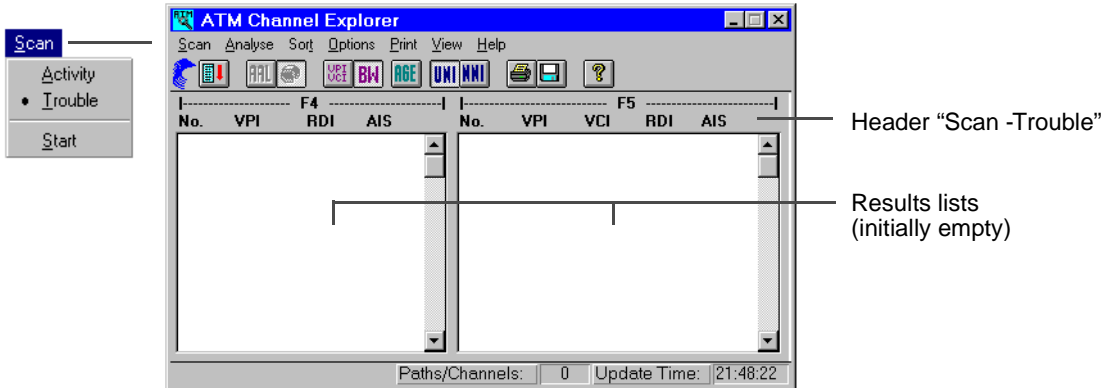

Fig. A-33 The "Scan" menu with selected "Trouble" scan type and corresponding results list

To start the scan



⇒ Click the above icon button of the toolbar or click "Start" in the "Scan" menu.
The scan starts. Channels detected are entered successively in the corresponding results windows.

Tip: To stop the scan click the icon button again or click "Start" in the "Scan" menu again.

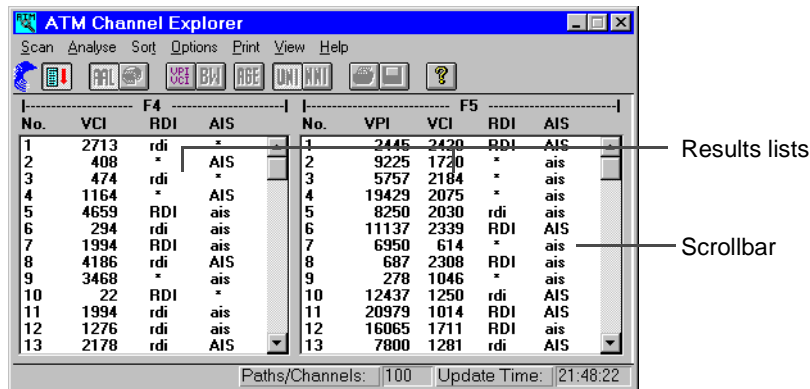

Fig. A-34 The "ATM Channel Explorer" with detected channels

A scan can only be started, when no other measurements that are started form the Application Manager are in progress or no test traffic is generated from the ATM Test Control VI. No other measurements can be started or no test traffic can be generated, while a scan is in progress.



Results lists

Each line corresponds to a channel exhibiting a RDI and/or an AIS alarm. A current alarm is indicated in upper-case letters (e.g. AIS). Previous alarms that are no longer active are indicated in lower-case letters (e.g. ais).

Column	Meaning
No.	Sequence number to assist orientation in the list
VCI	Virtual Channel Identifier. Displayed as a decimal number (only F5).
VPI	Virtual Path Identifier. Displayed as a decimal number.
RDI	Remote Defect Indication: Backward alarm.
AIS	Alarm Indication Signal: Forward alarm.

Table A-6 Trouble scan results list header

3.5 Selecting Options

To select the interface where the measurement is to be made



The icon buttons shown above (toolbar) are used to select the interface before starting the measurement. Each button corresponds to an interface type. Only one type can be selected, so clicking one button releases the other (toggle function).

- ⇒ Click the “UNI” button to measure on the “User-Network Interface”.
- or –
- ⇒ Click the “NNI” button to measure on the “Network-Node Interface”.

To sort out the inactive channels



The icon button in the toolbar shown above is used to sort out the inactive channels during the scan.

- ⇒ Click the “AGE” button to start the aging function.
- All channels that remain inactive over a period of 30 seconds will be deleted.

This dynamic process gives you a better picture of the actual traffic situation. This is particularly useful in an environment with switched virtual connections (SVC).



3.6 Sorting Channels

To sort the channels



The icon buttons shown above (toolbar) are used to sort the channels, i.e. to determine the order in which they are displayed in the result window. Each button corresponds to a sort criterion. Only one criterion can be selected, so clicking one button releases the other (toggle function).

- ⇒ Click the “VPI VCI” button to list the channels in ascending order of VPI/VCI values
– or –
- ⇒ Click the “BW” button to list the channels in ascending order of CuBW (Current Bandwidth) values.

The “BW” (Bandwidth) sort criterion is not available for “Trouble” scan.



Technical Background

1 ATM Traffic Generation and Multiplexing

VI: ATM Test Control

1.1 Overview

ATM test equipment takes on an important role in generating traffic profiles and multiplexing several virtual channels due to the specific characteristics of ATM technology. The requirements for a powerful test instrument are mainly concentrated in the following areas:

Traffic profile, source models

Suitable traffic profiles are needed to perform most of the tests required on ATM networks. This is particularly true of the ATM layer quality of service test. Suitable source models must be provided for the various types of traffic contract. These source models must be designed so that users can easily see the relationship between the parameters of the traffic contract under test and the parameters of the source model.

Multiplexer, traffic shaper

Since ATM does not use fixed (deterministic) bandwidth assignment, the individual virtual channels affect each other. The characteristics of traffic in one virtual channel, and hence the measurement results, do not just depend on the source settings, they are also dependent on what is happening in other channels. The multiplexing method used by the instrument also plays a part here. To ensure that adherence to the traffic contract can be guaranteed for each channel, the instrument must be able to shape the traffic profile using so-called traffic shapers. The type of traffic shaper used and its parameters depend on the characteristics of the traffic contract itself.

Background traffic

Since statistical multiplexing is used in ATM networks and network elements, a realistic measurement result is only obtained if background channels are also loaded in addition to the virtual channels to be tested. In most cases, the characteristics of traffic generated on the background channel must be precisely defined and known. This means that precisely controlled traffic has to be generated on several channels simultaneously.

1.2 Generator Principle

The traffic generator of the ANT-20SE or of the Broadband Analyzer/Generator simultaneously generates up to four test channels (software version 6.0). The generator produces quasi-statistical traffic according to different source models and model parameters. It is deterministic in the sense that the same instrument settings will always result in exactly the same traffic profile. This means that measurements can be reproduced precisely at any time.

The multiplexing method used operates on a fixed priority principle. Each of the four channels (A through D) is assigned a certain priority. This allows the channel that is to be most precisely measured to be given the highest priority (channel A). The traffic profile of this channel is only minimally influenced (some influence due to effects in the physical layer is unavoidable). Lower priority channels (e.g. channel D) are best used for background loads or for measurements of tolerant traffic contracts.

A traffic shaper can be activated for each of the four test channels if required. The traffic shaper parameters are determined by the requirements of the traffic contract defined for the channel.

Auxiliary channels, such as are used for the signaling, do not affect the traffic profile of the test channels. This is regardless of the bandwidth required for the auxiliary channels (as long as the total bandwidth available for the physical link is not exceeded).

1.3 Source Models

Two different source models are provided by the test instrument for the various ATM tests. Each channel defined in the Channel Editor (see Fig. TB-1) is assigned a traffic model (a) in the "Traffic Source" index card. The default values for the source parameters (b) are set on the same index card.

In the "Test Setup" dialog, you can select the channels generated in the Channel Editor and assign them to the current test type. The source of the channel is initialized to its default values when it is assigned.

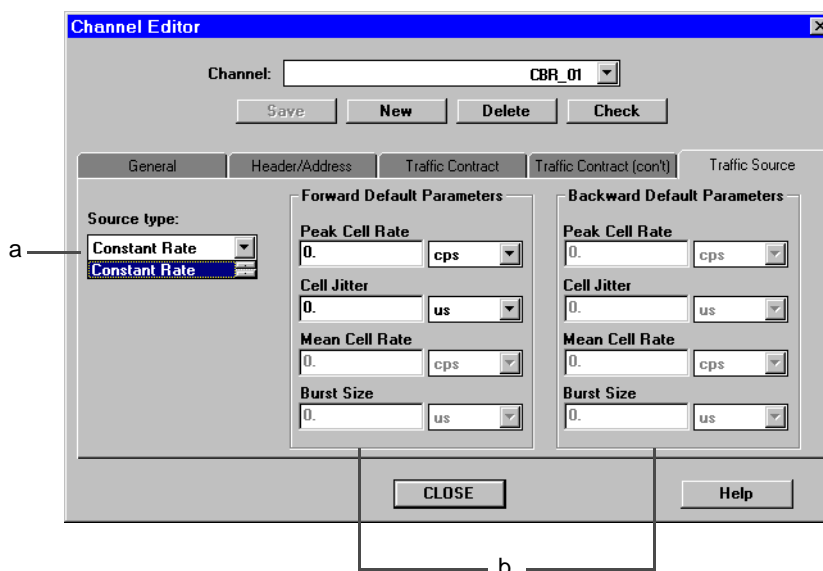

Fig. TB-1 The "Channel Editor" with activated "Traffic Source" index card



1.3.1 “Constant Bit Rate” source model

The “Constant Bit Rate” source model generates test cells at equidistant intervals in time, with fill cells inserted in the spaces (see Fig. TB-2). The desired traffic profile can be affected using the following parameters:

- Peak Cell Rate
- Cell Jitter

“Peak Cell Rate” specifies the nominal time spacing between test cells, Δt .

The “Cell Jitter” parameter is used to alter the nominal time spacing ($\rightarrow \Delta t'$) and thus cause a variation in the nominal cell arrival times. The profile used for this corresponds to an increasing ramp function.

The ramp rises until the cell arrival is advanced by the entered value. A gap then occurs in the cell arrival times to ensure that the correct mean cell rate is reached. The period of the ramp is based on the “Peak Cell Rate” setting and is calculated by the instrument automatically.

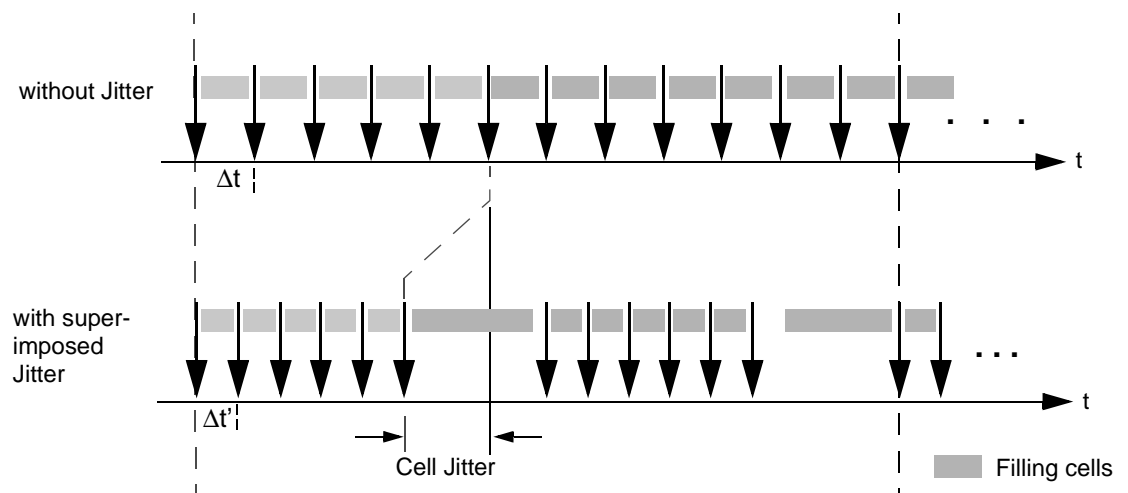

Fig. TB-2 Principles of “Constant Bit Rate” source model.

The specified jitter is superimposed on the source before multiplexing. Due to the unavoidable effects of multiplexing, the traffic profile actually transmitted may be modified again.

This source model is particularly suitable for testing CBR, DBR and UBR traffic contracts. The profile of the superimposed cell jitter makes it easy to test a traffic contract in respect of its Cell Delay Variation Tolerance ($CDVT_{PCR}$).

1.3.2 “On-Off” source model

The “On-Off” source model generates test cells in bursts. Fill cells are inserted in the gaps (see Fig. TB-3). The desired traffic profile can be influenced using the following parameters:

- Peak Cell Rate
- Mean Cell Rate
- Burst Size
- Cell Jitter

“Peak Cell Rate” specifies the nominal time spacing between test cells within a burst, Δt .

“Mean Cell Rate” specifies the mean cell rate.

“Burst Size” determines the length of a burst. The burst period to be used is calculated by the instrument automatically. It is largely based on the ratio of “Peak Cell Rate” to “Mean Cell Rate”.

The “Cell Jitter” parameter is used to cause a variation in the nominal cell arrival times. The profile used for this corresponds to an increasing ramp function. where the length of the ramp corresponds to the “Burst Size”.

The ramp rises until the cell arrival is advanced by the entered value. The gap between bursts is increased correspondingly to ensure that the correct mean cell rate is reached.

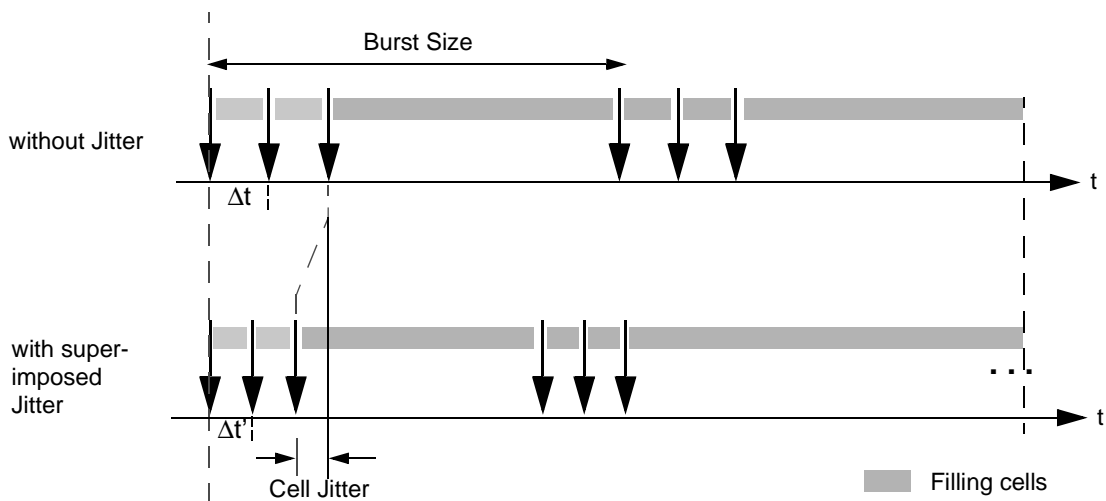

Fig. TB-3 Principles of “On-Off” source model

The specified jitter is superimposed on the source before multiplexing. Due to the unavoidable effects of multiplexing, the traffic profile actually transmitted may be modified again.

This source model is particularly suitable for testing VBR and SBR traffic contracts. The profile of the superimposed cell jitter makes it easy to test a traffic contract in respect of its Cell Delay Variation Tolerance ($CDVT_{PCR}$).



1.4 Traffic Control and Multiplexing Method

As well as being able to set the source parameters “off-line”, i.e. before starting the measurement, the “ATM Test Control” VI also allows you to change all the relevant source parameters “on-line”, i.e. during a measurement. The parameters are defined off-line using the “Test Setup” dialog (b) (see Fig. TB-4). In contrast, the “Test Online Control” dialog (c) is used to alter parameters on-line. Please note that each change in a source parameter results in a complete re-calculation of the entire multiplex.

Users should be aware that ATM multiplex formation makes it unavoidable that a changed setting in one channel (e.g Channel A, see index card (a)) may also affect the other channels (i.e. Channels B, C and D). This is particularly the case where the physical link is loaded to a high percentage.

The channel priorities for the multiplex procedure are fixed by two rules, whereby rule 1 has precedence over rule 2.

Rule 1

Channels with a bit rate above 2.5 Mbit/s have priority over channels with a bit rate below 2.5 Mbit/s. This rule takes account of the fact that lower bit rate channels usually allow a higher CDVT than that of higher bit rate channels.

Rule 2

The priority of the channels decreases from left to right, i.e. channel A has the highest priority, channel B the next highest, and so on.

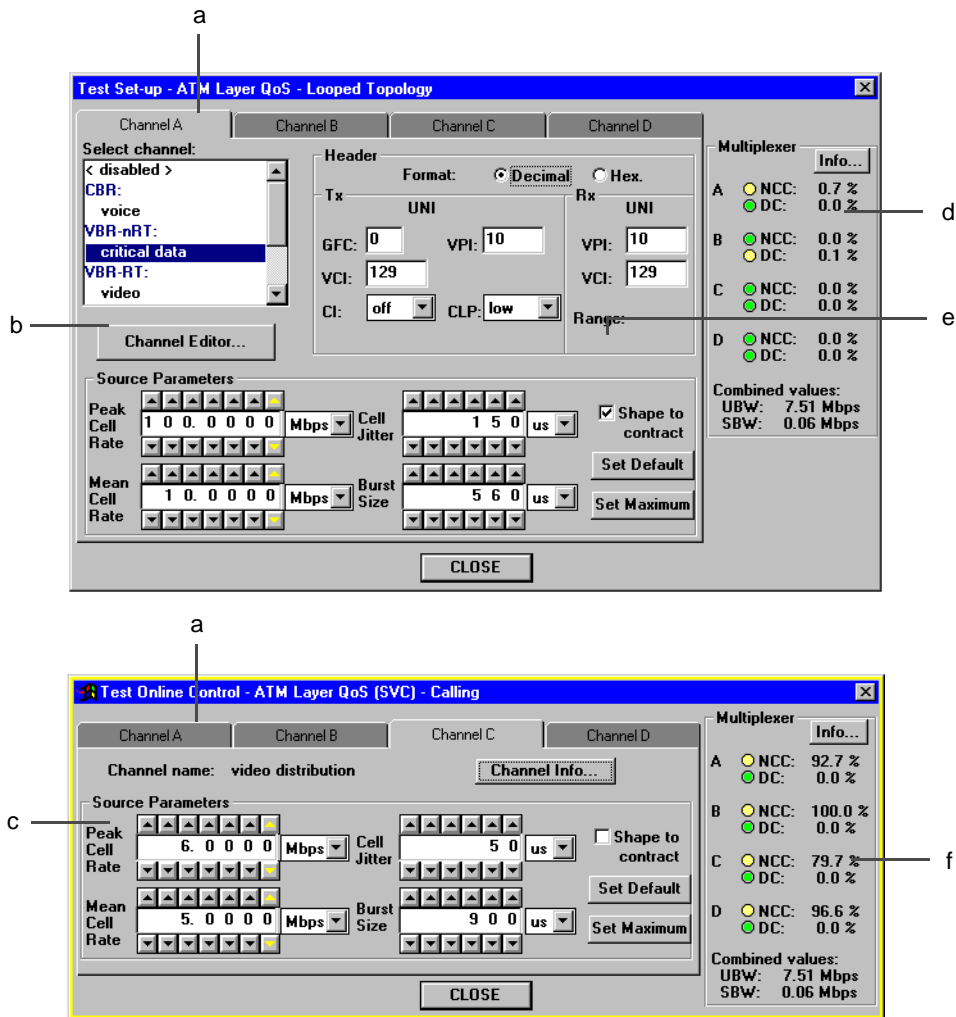

Fig. TB-4 “Test Setup” and “Test Online Control” dialog windows with index cards and “Multiplexer” section

To make it easier to see the complex procedures during multiplex formation, an overview of the status of each channel is given in the “Multiplexer” field.

In the “Test Setup” dialog, this information (d) has the character of a traffic prediction, as the generator is not yet active. This makes it possible to set the generator precisely, before starting the measurement.

In the “Online Control” dialog, in contrast, this information (f) reflects the actual status of the channel. The following information is provided:



Multiplexer results for permanent virtual connections (PVC)

Display	Meaning
Numerical display	
A ... D	Test channel name
DC: ...	“Dropped Cell Count” display: Percentage of dropped cells referred to the mean cell rate of the channel. Dropped cells occur if the bandwidth set for a channel cannot be reached. This happens if the overall bandwidth is exceeded or if the traffic contract forces it (with traffic shaper switched on). The yellow indicator means DC > 0%.
NCC: ... %	“Non Conforming Cells” display: Percentage of cells that do not conform to the traffic contract referred to the mean cell rate of the channel. The yellow indicator means NCC > 0%.
Combined values BW: ... %	Display of the total generated bit rate in Mbit/s. This includes the bandwidth reserved for the auxiliary channels (e.g. signaling channels). The yellow indicator means that the multiplexer is dropping cells.
Software indicators	
The indicators give a rapid overview of any anomalies in the generated traffic mix.	
Green means	No anomalies were detected
Yellow means	Anomalies were detected

Table TB-1 Multiplexer results with PVCs

Multiplexer results for switched virtual connections (SVCs)

It is not possible to make a precise prediction of the generated traffic profiles for switched virtual connections (SVC) because the traffic mix that occurs may vary in time. This depends, among other things on the order in which the connections are switched in the ATM network. The preview therefore includes the following information:

Display	Meaning
Numerical display	
A ... D	Test channel name.
... Mbps	Average cell rate in Mbit/s.
Combined values UBW: ... Mbps SBW: ... Mbps	Display of overall generated bit rate in Mbit/s. Display of bandwidth reserved for auxiliary channels (signaling channel) in Mbit/s

Table TB-2 Multiplexer results for switched virtual connections (SVCs)

Tip: After the start of a measurement, the multiplexer field contains the same information as for permanent virtual connections.

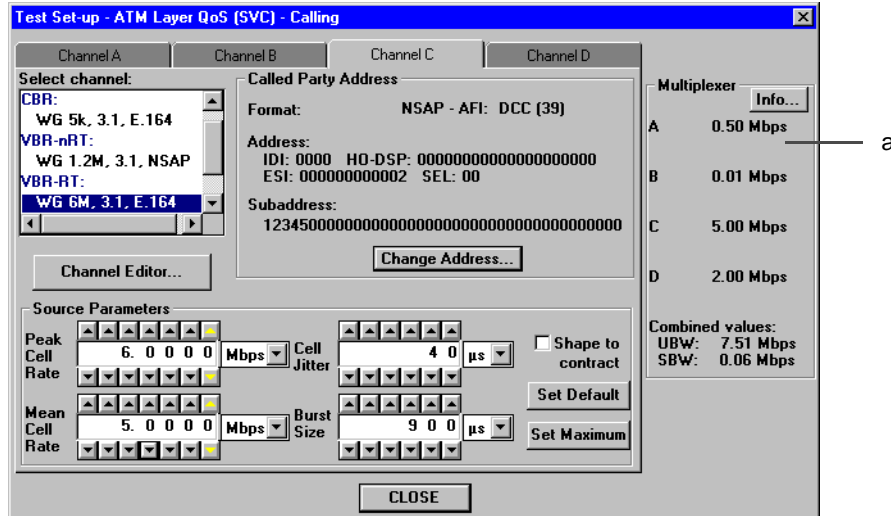

Fig. TB-5 “Test Setup” dialog for SVC connections with Multiplexer section (a)

1.5 Traffic Shaper

If the “Shape to Contract” option is activated, the instrument shapes the set traffic profile. Shaping occurs whenever the traffic contract would otherwise be violated. This means that conformance to the traffic contract is guaranteed when the option is activated.

With traffic shaping, cells that would otherwise violate the traffic contract, e.g. by exceeding the permitted CDVT or burst tolerance, are pushed back on the time axis until they can be transmitted without violating the traffic contract. The cells are always transmitted at the earliest possible moment.

If traffic shaping takes place, it is basically unavoidable that the traffic profile is altered by the shaper. The shaper algorithm used is designed to keep changes to the traffic profile as small as possible.

Activation of the traffic shaper may cause cells to be dropped if the traffic contract cannot be met in any other way.

Type of traffic contract	Traffic shaper used
CBR	Compatible with “Single Leaky Bucket”
DBR	Compatible with “Single Leaky Bucket”
VBR	Compatible with “Dual Leaky Bucket”
SBR	Compatible with “Dual Leaky Bucket”
UBR	Compatible with “Single Leaky Bucket”

Table TB-3 Verkehrstypen und zugeordnete “Traffic Shaper”



2 Testing Switched Virtual Circuits (SVCs)

VI: ATM Test Control and ATM Test Results

2.1 General features of the signaling (Software version 6.5)

The signaling functions of a terminal on the user-network interface (UNI) are emulated. The implementation used has the following features:

- Support for “Calling”, “Called” and “Self Call” modes.
- The signaling channel is freely selectable. The default setting is VPI=0, VCI=5.
- “Associated” and “Non-associated” signaling can be selected (for Q.2931 only).
- The following standards are supported:
 - IITU-T Q.2931
 - ITU-T Q.2961
 - ATM Forum UNI 3.0
 - ATM Forum UNI 3.1
- The following signaling AAL standards are supported:
 - ITU-T Q.2110
 - ITU-T Q.2130
 - ITU-T Q.SAAL.1
 - ITU-T Q.SAAL.2
- The following address formats are supported:
 - Native E.164
 - NSAP ICD
 - NSAP DCC
 - NSAP E.164
 - NSAP E.191
- Sub-addresses are supported

2.2 Interoperability with other instruments

The ANT-20SE completely fulfills the quoted standards. If you make a connection to any other instrument, please note the following:

- The setup message that is generated contains the following information elements (IE):
 - Protocol discriminator
 - Call reference
 - Message type
 - AAL parameter: User defined AAL (only if the “User defined AAL type” option is selected; otherwise this IE is omitted.)
 - ATM user cell rate
 - Broadband bearer capability: BCOB-X
 - Called party number
 - Called party subaddress (only if subaddresses are used)
 - Calling party number
 - Calling party subaddress (only if subaddresses are used)
 - QoS parameters

- A connection is accepted if:
 - The called party address is the same as the instrument address
 - The setup message has the format given above
 - The stated contract parameters are plausible and the instrument is capable of generating the required cell stream. This also applies, even if traffic generation is disabled.
 - The instrument does not already have four active connections.
- Layer 2 (Signaling - AAL) is implicitly configured by the choice of signaling protocol. The following rule applies:
 - UNI 3.1, Q.2931: SSCOP to Q.2110, SSCF to Q.2130
 - UNI 3.0: SSCOP to Q.SAAL.1, SSCOP to Q.SAAL.2

2.3 Starting and stopping signaling, generating test traffic

- The signaling emulation starting and stopping points are coupled to the measurement sequence control of the Application Managers.
 - No virtual connections are present outside the measurement interval. This means that no resources are occupied in the device under test outside the measurement interval. This can be important, particularly with timer-controlled measurements.
 - Generation of test traffic begins on a virtual channel as soon as the connection is switched. It ends when the connection is cleared down. This assumes that test traffic has been enabled (“Traffic Enable”).
- Test traffic generation can be affected manually. Two types of traffic generation are possible:
 - SVC test with “Bearer Test”:
If the “Traffic Enable” command is activated before starting the measurement or if the “Automatic Traffic Enable” option is enabled, the instrument starts generating test traffic as soon as a connection is switched.
 - SVC test without “Bearer Test”:
If the “Traffic Enable” command (or the corresponding icon button) is deactivated before the start of the measurement and the “Automatic Traffic Enable” option is disabled, the instrument will not generate test traffic.

The test traffic can be switched on or off at any time during a measurement using the “Traffic Enable” command (or the corresponding icon button).

2.4 “Calling” mode

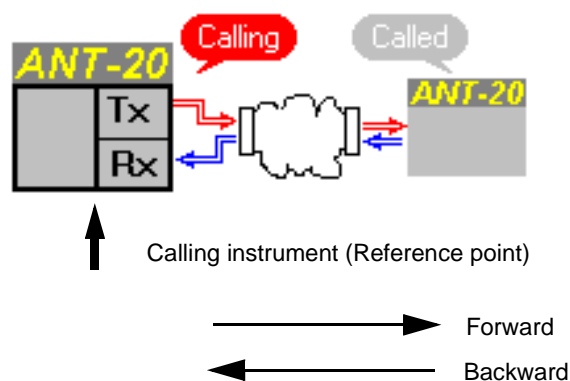

Fig. TB-6 Configuration diagram (VI “ATM Test Control”)



Features

- Measurement of the QoS parameters starts (“ATM Test Results” VI) as soon as a connection has been set up.
- If test traffic has been enabled, it will be generated as soon as a connection is set up.
- The contents of the log file are deleted (“ATM Test Results” VI) when the measurement starts.
- NCS (Not Connected Seconds) results are registered all the time no connection is present (Disconnected State).
- If a connection is not established on the first call, a new call will be made automatically after about 4 seconds. After this, no further call attempts are made.
- When several channels are being measured, the calls for setting up each connection are staggered in time.
- If the “Log QoS Parameters” (“ATM Test Results” VI) is activated, the QoS results will be recorded in the log file after the connection is cleared down.
- Channel-specific errors can be inserted all the time that the virtual channel is set up.

Test type: “ATM Layer QoS (SVC) - Calling”

Settings and operating sequence





VI	Calling instrument	Called instrument
	Switch on instrument and select virtual instruments <ul style="list-style-type: none"> • ATM Test Control • ATM Test Results • Signal Structure • other VIs as required 	Switch on instrument and select virtual instruments <ul style="list-style-type: none"> • ATM Test Control • ATM Test Results • Signal Structure • other VIs as required
	Configure instrument <ol style="list-style-type: none"> 1. Configure physical layer 2. Select “Emulate” topology 3. Enable signaling 4. Configure signaling 5. Select test type “ATM Layer QoS (SVC) - Calling” 6. Configure test 7. Select “Traffic” Enable” or activate “Automatic Traffic Enable” option if necessary 	Configure instrument <ol style="list-style-type: none"> 1. Configure physical layer 2. Select “Emulate” topology 3. Enable signaling 4. Configure signaling 5. Select test type “ATM Layer QoS (SVC) - Called” 6. Select “Traffic” Enable” or activate “Automatic Traffic Enable” option if necessary
	⇒ Start and stop measurement	⇒ Start measurement
	⇒ Evaluate the results for the backward direction	⇒ Evaluate the results for the forward direction

Table TB-4 Settings and operating sequence

To ensure that the connection can be switched, you should make sure that the measurement in the “called” instrument is started first. After this, you should start the “calling” instrument or trigger the measurement.

Time sequence

After the measurement is started (Application Manager) the following automatic sequence begins. The sequence is split into 4 phases:

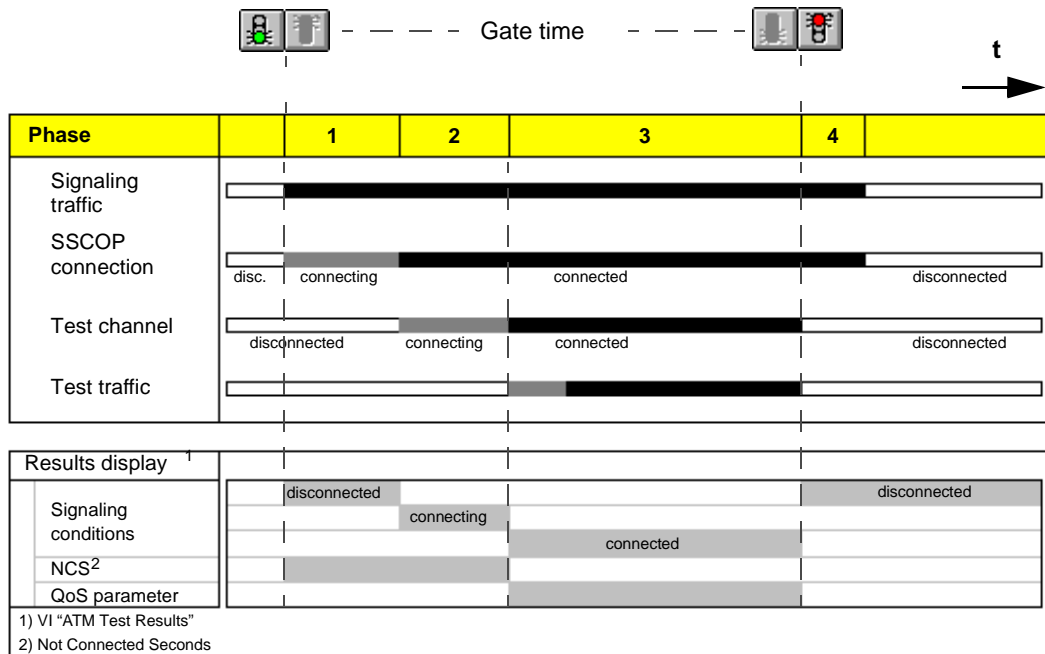

Fig. TB-7 Time sequence at ATM traffic generation, "Calling" mode (only one channel)

Phases

1. The measurement is started:
The layer 2 signaling (SSCOP) connection is set up.
2. The test channel is switched.
3. Test traffic is generated if it has been enabled.
QoS parameters are measured
4. The measurement is stopped. The test channel is cleared down; if required, the QoS parameters are recorded in the log file.

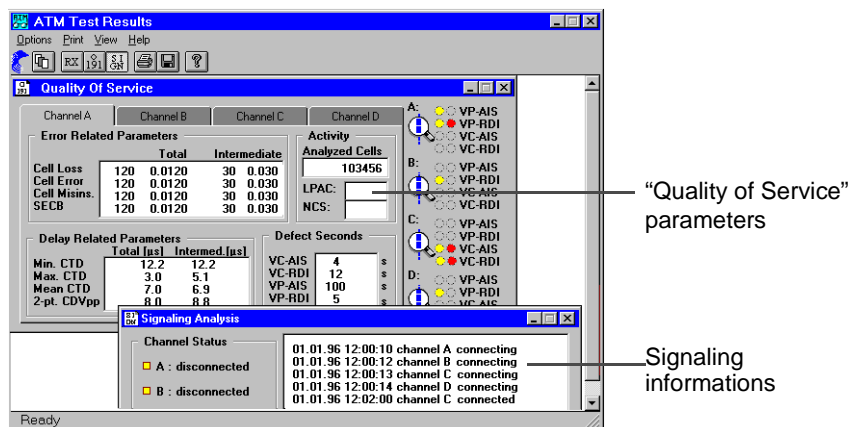

Fig. TB-8 Displaying of results (VI "ATM Test Results")



2.5 “Called” mode

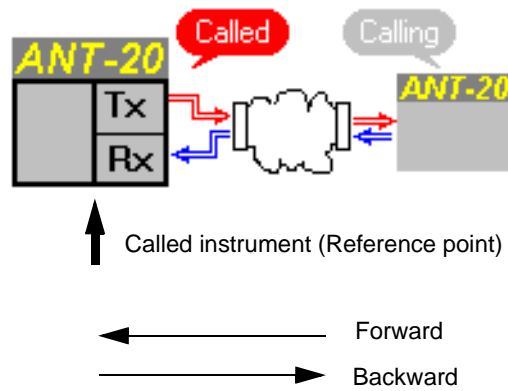

Fig. TB-9 Configuration diagram (VI “ATM Test Control”)

Features

- The “called” instrument is ready to receive calls during the measurement interval. Calls occurring outside the measurement interval will not be accepted.
- The contents of the log file are deleted (“ATM Test Results” VI) when the measurement starts.
- When a connection is accepted, the QoS parameters are measured for the duration of the connection. When a new connection is accepted, the previous measured values will be reset, i.e. the parameters are determined afresh for each connection. If you want to save the data from previous measurements, activate the “Log QoS Parameters” option (“ATM Test Results VI”).
The NCS value is not reset. NCS results are always determined over the entire measurement period.
- If a connection is accepted, the type of source model and the source parameters for the measurement are determined from the information in the setup message. The source is initialized so that the traffic contract is loaded as fully as possible.
Test traffic generation starts immediately after the connection is switched (assuming traffic generation is enabled).
- NCS (Not Connected Seconds) results are registered during intervals when no connection exists (Disconnected State).
- If the “Log QoS Parameters” option (“ATM Test Results” VI) is activated, the QoS results are written to the log file after each clearing down of a connection.
- Channel-specific errors can be inserted all the time that the virtual channel is set up.



Test type: “ATM Layer QoS (SVC) - Called”

Settings

Basically the same as for “Calling” mode (see Sec. 2.4) but the test types in “Configure instrument” are reversed.

Time sequence

After the measurement is started (Application Manager) the following automatic sequence begins. The sequence is split into 5 phases:

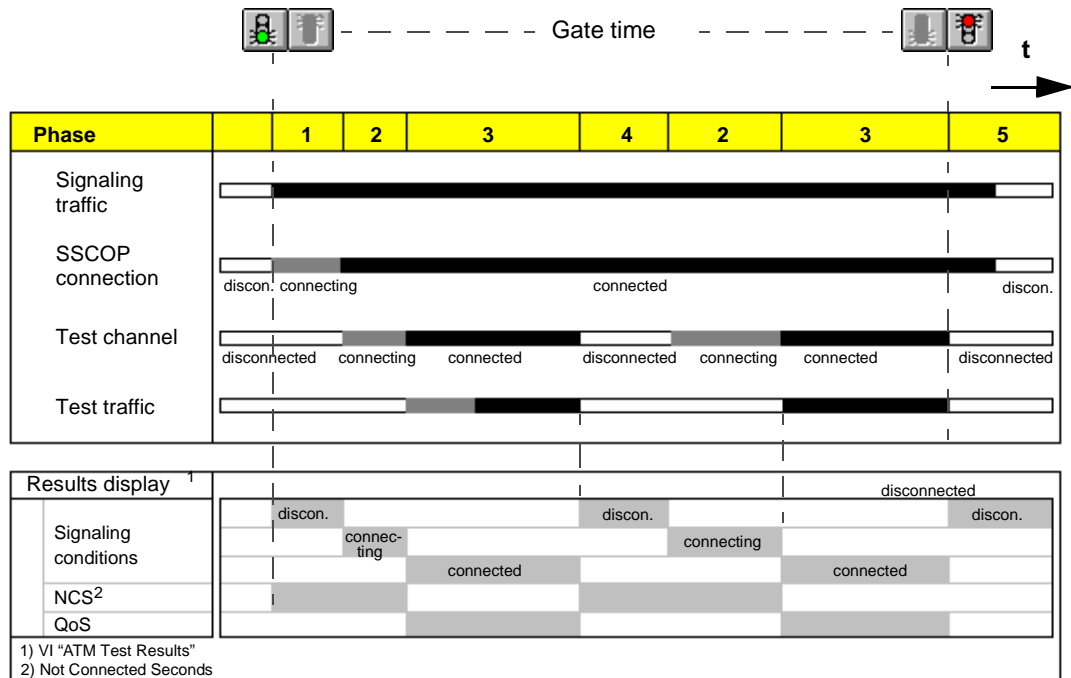

Fig. TB-10 Time sequence at ATM traffic generation, “Called” mode: During the gate time, two calls were accepted

Phases

1. The measurement is started:
The layer 2 signaling (SSCOP) connection is set up.
2. A connection (virtual channel) is switched as soon as a call is received.
3. The connection is set up. Test traffic is generated if it has been enabled by the user.
4. The connection is cleared down. The QoS parameters are saved in the log file as required.
The measurement is stopped. An existing connection is cleared down. The QoS parameters are saved in the log file as required.

Phases 2, 3 and 4 can be repeated as many times as required during the measurement interval.



2.6 “Self Call” mode

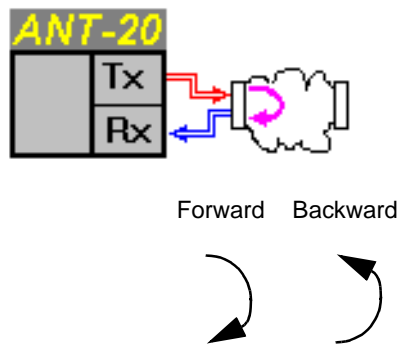

Fig. TB-11 Configuration diagram (VI “ATM Test Control”)

Features

“Self Call” mode is a combination of “Calling” (see Sec. 2.4) and “Called” modes (see Sec. 2.5). In the forward direction, the self-call has the characteristic of the calling instrument. In the backward direction, the instrument behaves like a called instrument.



Notes:



Specifications “ATM Layer”

1 Generator

1.1 Scrambling

The cell payload is scrambled as per ITU-T recommendation I.432 ($X^{43} + 1$).
The scrambler can be disabled.

1.2 Fill Cells

The fill cell type is selectable. IDLE or UNASSIGNED cells can be used.

1.3 Cell Header

UNI/NNI Modus	selectable ¹
GFC	selectable ²
VPI, VCI	selectable ³
CI (congestion indicator)	selectable ²
CLP (cell loss priority)	selectable ²
HEC	formed automatically

1 Set to UNI automatically for SVC.

2 Selectable for PVC. Set automatically for SVC (0 set).

3 Selectable for PVC. Set automatically for SVC.



1.4 General Functions

1.4.1 Error Insertion (Anomalies)

The following anomalies can be inserted in addition to the errors inserted in the physical layer. These anomalies are not dependent on the active measurement type, they are referred to the entire cell stream including fill cells.

Error type, anomaly	Single	Rate ¹	Sensor threshold
			M in N
HEC uncor. ²	yes	1E-2 to 1E-6	M=1 to 31 N = M+1 to M + 31
HEC cor. ³	yes	1E-2 to 1E-6	M =1 to 31 N = M +1 to M + 31
1 Mantissa = 1 (fixed), exponent = -2 to -6 (integer values) 2 Uncorrectable header error 3 Correctable header error			

Table S-1 Settable anomalies

1.4.2 Alarm Generation (Defects)

The following defects can be generated in addition to the physical layer alarms. These defects can be generated independently of the active measurement type. They are referred to the entire cell stream.

Defect	Test sensor functions	Single
	On/Off	
LCD ¹	yes	yes
1 LCD (Loss of Cell Delineation) is generated if uncorrectable header errors are found in seven or more consecutive cells.		

Table S-2 Settable defects



1.5 Functions for ATM Layer Quality of Service Measurements

1.5.1 General

Number of test channels4
Source models	“Constant Bit Rate”, “On-Off”
Traffic Shaper ¹	“Single Leaky Bucket”, “Dual Leaky Bucket”
Maximum total bandwidth of all test channel	366792 cells/s ²

1 Can be disabled

2 In practice, the upper limit is given by the physical mapping

1.5.2 Error Insertion (Anomalies)

The following anomalies can be inserted selectively into each of the 4 test channels. All anomalies are inserted as a single event.

Uncorrectable header error	HUNC
Correctable header error	HCOR
Cell loss	Cell Loss
Cell error	Cell Error
Cell misinsertion	Cell Misins.
Severely errored cell blockSECB

1.5.3 Alarm Generation

The following defects can be generated selectively on each of the 4 test channels. All defects are generated as “on/off” functions.

F5 layer (VC) Alarm Indication SignalVC-AIS
F4 layer (VP) Alarm Indication SignalVP-AIS
F5 layer (VC) Remote Defect Indication	VC-RDI
F4 layer (VP) Remote Defect Indication	VP-RDI

1.5.4 Test Cell Format

Test cell format conforms with ITU-T recommendation O.191, issue of 9th January 1997.

Transmission timestamp resolution	640ns ¹
---	--------------------

1 The lowest value bits of the timestamp are always set to 0



1.6 Source Models

1.6.1 Constant Bit Rate Model

A cell stream with nominally constant cell spacing is generated.

Parameters	peak cell rate and cell jitter ¹
Peak cell rate	0 bis 366792 cells/s ¹
Peak cell rate units	cells/s, Mbit/s, kbit/s
Peak cell rate resolution	1 cell/s
Maximum possible cell jitter ²	depends on the peak cell rate and the mapping setting
Jitter profile	periodic ramp ³
Jitter units	μs, ms
Jitter resolution	1 μs

- 1 In practice, the upper limit is given by the physical mapping.
- 2 This is the source model jitter. The jitter in the actual data stream is the sum of the source model jitter, the multiplex jitter and the intrinsic jitter of the generator. The intrinsic jitter of the generator is largely determined by the mapping and is hence strongly dependent on the physical cell rate.
- 3 Cell arrival times are reduced over a certain time interval until the set jitter amplitude is reached. A gap then occurs in the cell stream to ensure that the correct mean cell rate is achieved.

1.6.2 “On-Off” Model

A burst-type cell stream with on/off character is generated.

Parameters	peak cell rate, mean cell rate, burst size and cell jitter
Peak cell rate	0 to 366792 cells/s ¹
Peak cell rate units	cells/s, Mbit/s, kbit/s
Peak cell rate resolution	1 cell/s
Mean cell rate	0 to 366792 cells/s ¹
Mean cell rate units	cells/s, Mbit/s, kbit/s

- 1 In practice, the upper limit is given by the physical mapping.



Mean cell rate resolution	1 cell/s
Maximum burst size	depends on the settings for mean cell rate and peak cell rate
Burst size units	μ s, ms
Burst size resolution	1 μ s
Maximum possible cell jitter	depends on the peak cell rate and the mapping setting
Jitter profile	periodic ramp, standardized on burst size ¹
Jitter units	μ s, ms
Jitter resolution	1 μ s

1 Cell arrival times are reduced within the burst so that the set jitter amplitude is achieved.

1.7 Traffic Shaper

1.7.1 Traffic Shaper for CBR, UBR and DBR Traffic Contracts

Algorithm	compatible with single leaky bucket
Parameters	peak cell rate and $CDVT_{PCR}$ ¹
Peak cell rate range0 to 366792 cells/s
Peak cell rate unitscells/s, Mbit/s, kbit/s
$CDVT_{PCR}$ range0 to 16,383 ms
$CDVT_{PCR}$ units	μ s, ms

1 "Cell Delay Variation Tolerance" referred to the peak cell rate.



1.7.2 Traffic Shaper for VBR and SBR Traffic Contracts

Algorithm	compatible with dual leaky bucket
Parameters	peak cell rate, sustainable cell rate, burst tolerance, $CDVT_{SCR}$ and $CDVT_{PCR}$
Peak cell rate range.	0 to 366792 cells/s
Peak cell rate units	cells/s, Mbit/s, kbit/s
Sustainable cell rate range	0 bis 366792 Cells/s
Sustainable cell rate units	cells/s, Mbit/s, kbit/s
Burst tolerance range	0 to 999.99 ms
Burst tolerance units μ s, ms
$CDVT_{PCR}$ range.	0 to 16.383 ms
$CDVT_{PCR}$ units μ s, ms
$CDVT_{SCR}$ range.	0 to 16.383 ms
$CDVT_{SCR}$ units μ s, ms

1 "Cell Delay Variation Tolerance" referred to the sustainable cell rate.



2 Receiver

2.1 Descrambling

Descrambling as per ITU-T recommendation I.432 ($X^{43} + 1$).
The Descrambler can be disabled.

2.2 General Functions

2.2.1 Error Measurements (Anomalies)

The following anomalies are evaluated and displayed in addition to the errors on the physical layer. These errors are detected for the entire cell stream.

Anomaly	Count	Explanation
HEC Error Count correctable	yes	Correctable cell header errors
HEC Error Count uncorrectable	yes	Uncorrectable cell header errors

Table S-3 Display of possible anomalies

2.2.2 Alarm Detection (Defects)

Defect	LED	Defect Seconds Count ¹	Explanation
Loss of Cell Delineation	Software LEDs for history and actual status	yes	Loss of cell synchronization
Physical Layer Defect	Software LEDs for history and actual status	yes	Sum alarm for physical layer errors. Activated when an analyzable cell stream is no longer present.

¹ A "Defect Second" is counted if the event occurs at least once within a one-second interval.

Table S-4 Display of possible defects

2.2.3 Receiver Bandwidth

Display of momentary bandwidth of all virtual channels in the physical connection in Mbit/s and as a percentage. The percentage is referred to the theoretical maximum bandwidth for the selected mapping setting.



2.3 ATM Layer Quality of Service Measurements

2.3.1 General Features

Number of measurement channels	4
Maximum measurement channel bandwidth	366792 cells/s ¹
Maximum total bandwidth of all test channels	366792 cells/s ¹

1 In practice, the upper limit is given by the physical mapping.

2.3.2 Error Related Parameters

Measurement algorithm conforms to ITU-T recommendation O.191, issue of 9th January 1997.

The following parameters are measured as count and rate (or ratio) values.

- Cell loss
- Cell error
- Cell misinsertion
- Severely errored cell block, SECB

The “Analyzed Cell Count” is also indicated.

2.3.3 Delay Related Parameters

Delay measurements are only possible if the generator cell stream is looped back to the receiver, i.e. when the instrument receives its own cell stream again.

Minimum cell transfer delay	min. CTD
Maximum cell transfer delay	max. CTD
Mean cell transfer delay	mean CTD
2-point cell delay variation	2-pt. CDV _{PP}



2.3.4 Alarm Detection (Defects)

Defect	LED	Defect Seconds Count ¹	Explanation
VC-AIS	Software LEDs for history and actual status	yes	F5 layer (VC) Alarm Indication Signal
VP-AIS	Software LEDs for history and actual status	yes	F4 layer (VP) Alarm Indication Signal
VC-RDI	Software LEDs for history and actual status	yes	F5 layer (VC) Remote Defect Indication Signal
VP-RDI	Software LEDs for history and actual status	yes	F4 layer (VP) Remote Defect Indication Signal

1 A "Defect Second" is counted if the alarm state occurs at least once within a one-second interval.

Table S-5 Display of possible defects

2.3.5 Other Parameters

The following parameters are indicated as a count of defect seconds¹.

"Loss of Performance Assessment Capability" LPAC
 "Not Connected Seconds" NCS²

1 A "Defect Second" is counted if the event occurs at least once within a one-second interval.

2 Only occurs for SVCs.

The "Loss of Performance Assessment Capability" state is detected if it is no longer possible to measure the error and delay-related parameters due to major disruption of the cell stream.

The "Not Connected" applies when no virtual connection is switched.



2.4 Channel Explorer

2.4.1 Activity Scan

Automatic detection of active virtual channels. Channels are distinguished by VCI and VPI. UNI and NNI interface types can be selected.

Maximum number of channels detectable simultaneously 1000
 Sort function unsorted¹
 sorted by VPI/VCI
 sorted by bandwidth

The following parameters are measured for each detected channel:

Average bandwidth AvBW² [Mbps]
 Current bandwidth CuBW³ [Mbps]
 Proportion of cells with Congestion Indicator set CI-BW⁴ [%]
 Proportion of cells with Cell Loss Priority Bit set CLP1-BW⁵ [%]

An “aging” function can be activated optionally. This function deletes all channels that have not shown any activity for at least 30 seconds from the list of active channels.

2.4.2 Trouble Scan

Automatic detection of AIS and RDI alarms. Simultaneous display of F4 layer alarms (virtual path) and F5 layer alarms (virtual channel). UNI and NNI interface types can be selected.

Maximum number of simultaneously
 detectable OAM flows (F4 or F5 layer) 1000
 Sort function unsorted¹
 sorted by VPI/VCI

- 1 Unsorted means that the channels are displayed in chronological order of detection.
- 2 The average bandwidth is the average over the time that has elapsed since the channel was detected.
- 3 The current bandwidth is the average for the last 10-second interval.
- 4 Referred to the average bandwidth.
- 5 Referred to the average bandwidth.



2.4.3 AAL analysis

Automatic detection of AAL type for all channels detected during an Activity Scan.

Maximum number of simultaneously analyzed channels	1000
Different AAL types	AAL1, AAL3/4, AAL5, undetected ¹ , unchecked ²

It is also possible to display the AAL type distribution graphically (pie chart). The proportion of each AAL type is given as a percentage.

- 1 Undetected means that the AAL type cannot be determined (e.g. an unknown AAL type or a severely errored cell stream).
- 2 Unchecked means that the AAL type for the channel in question was not tested (e.g. because analysis was terminated earlier by the user).



3 Signaling

The instrument simulates the signaling functions of a terminal on the user-network interface (UNI). Up to 4 connections can be switched simultaneously.

“Channel associated signaling” can be selected as an option. Subaddresses can also be optionally used.

Signaling standards	ITU-T recommendation Q. 2931, ITU-T recommendation Q. 2961, ATM Forum recommendation UNI 3.0, ATM Forum recommendation UNI 3.1
Modes	“Calling”, “Called”, “Self Call”
Address formats	Native E. 164, NSAP ICD, NSAP DCC, NSAP E.164, NSAP E.191
Signaling channel (VPI/VC1)	user definable

1 Only possible if ITU-T recommendation Q. 2931 protocol is selected.

3.1 Traffic Contracts

Traffic types	“CBR”, “DBR”, “UBR”, “VBR-RT”, “VBR-nRT”, “SBR” ¹
Quality of Service classes	1, 2, 3, 4
Connection type	point-to-point
Direction	bi-directional, symmetrical bi-directional asymmetric

1 CBR: “Constant Bit Rate”, DBR: “Deterministic Bit Rate”, UBR: “Unspecified Bit Rate”, VBR-RT: “Variable Bit Rate - Real Time”, VBR-nRT: “Variable Bit Rate - non Real Time”, SBR: “Statistical Bit Rate”.
CBR, UBR, VBR-RT and VBR-nRT are ATM Forum traffic types. SBR and DBR are ITU “Bearer Capabilities”.

3.2 Signaling Analysis

Detection and display of the connection status of up to 4 connections simultaneously.

Displayed states disconnected, connecting, connected

Measurement of the connection setup time (“Channel Setup Time”).



4 Note for ANT-20SE users

The following hardware and software bundles have been formed for the ANT-20SE.

Assignments of modules and software ANT-20SE – ANT-20/ANT-20E:

	Module / Software	BN number ANT-20SE	Equivalent BN number
ANT-20SE Mainframe	Mainframe, SDH	3060/01	3035/41 or 3035/21 + 3035/92.15 + 3035/93.11 + 3035/90.01
	Mainframe, SONET	3060/02	3035/42 or 3035/22 + 3035/92.15 + 3035/93.11 + 3035/90.10
	Extended SDH Testing	3060/90.01	3035/90.02, 3035/90.03, 3035/90.04, 3035/90.05, 3035/90.06, 3035/90.15
	Extended SONET Testing	3060/90.02	3035/90.11, 3035/90.12, 3035/90.13, 3035/90.03, 3035/90.15
	Add SONET (SONET expansion for SDH mainframe)	3060/90.03	3035/90.10, 3035/90.11, 3035/90.12, 3035/90.13, 3035/90.34
	Add SDH (SDH expansion for SONET mainframe)	3060/90.04	3035/90.01, 3035/90.02, 3035/90.04, 3035/90.05, 3035/90.06, 3035/90.33
	Drop&Insert (Through mode, Block&Replace)	3060/90.10	3035/90.20
	PDH MUX/DEMUX (64/140)	3060/90.11	3035/90.30
	M13 MUX/DEMUX	3060/90.12	3035/90.32
Optics STM-1/4, OC-1/3/12	STM-1, OC-1/3 1310 nm	3060/91.01	3035/90.43 + 2 Adapters
	STM-1, OC-1/3 1310 nm & 1550 nm	3060/91.02	3035/90.45 + 2 Adapters
	STM-1/4, OC-1/3/12 1310 nm	3060/91.11	3035/90.46 + 2 Adapters
	STM-1/4, OC-1/3/12 1310 nm & 1550 nm	3060/91.12	3035/90.48 + 2 Adapters
	Optical power splitter	3060/91.05	3035/90.49 + 3 Adapters
	OC-12c BULK	3060/90.90	3035/90.90
	OC-12c Virtual concatenation	3060/90.92	3035/90.92

Table O-6 Assignments of modules and software



	Module / Software	BN number ANT-20SE	Equivalent BN number
Optics STM-16, OC-48	STM-16, OC-48 1550 nm	3060/91.50	3035/91.53 + 2 Adapters
	STM-16, OC-48 1310 nm	3060/91.51	3035/91.54 + 2 Adapters
	STM-16, OC-48 1310 nm & 1550 nm	3060/91.52	3035/91.59 + 2 Adapters
	STM-16, OC-48 15... nm, special	3060/91.53	3035/90.38 + 2 Adapters
	OC-48c BULK	3060/90.93	3035/90.93
	Package: STM-0/1/4/16 1310 nm + Concatenation	3060/90.55	3035/90.46, 3035/91.54, 3035/90.90, 3035/90.93, + 4 Adapters
	Package: STM-0/1/4/16 1550 nm + Concatenation	3060/90.56	3035/90.47, 3035/91.53, 3035/90.90, 3035/90.93, + 4 Adapters
	Package: STM-0/1/4/16 1310 nm & 1550 nm + Concatenation	3060/90.57	3035/90.48, 3035/91.59, 3035/90.90, 3035/90.93, + 4 Adapters
	Package: STM-0/1/4 1310 nm STM-16 1550 nm + Concatenation	3060/90.58	3035/90.46, 3035/91.53, 3035/90.90, 3035/90.93, + 4 Adapters
Jitter O.172	Package: O.172 Jitter/Wander up to 155 Mbit/s	3060/91.30	3035/90.81, 3035/90.85, 3035/90.82, 3035/90.86
	Package: O.172 Jitter/Wander up to 622 Mbit/s	3060/91.31	3035/91.31
	Package: O.172 Jitter/Wander up to 2488 Mbit/s	3060/91.32	3035/91.32
	MTIE/TDEV Analysis Part of 3060/91.30 to 91.32	-	3035/95.21
ATM	ATM Basic	3060/90.50	3035/90.70
	ATM Comprehensive	3060/90.51	3035/91.80
	Add ATM SDH	3060/90.52	3035/90.72, 3035/90.74, 3035/90.75, 3035/90.77, 3035/90.33
	Add ATM SONET	3060/90.53	3035/90.71, 3035/90.73, 3035/90.76, 3035/90.34,
	OC-12c ATM Testing	3060/90.91	3035/90.91
Accessories	Remote control, V.24	3035/91.01	
	Remote control, GPIB	3035/92.10	
	Remote Operation Modem	3035/95.30	
	Remote Operation LAN/PCMCIA	3035/95.31	
	PDH/SDH NEXT Expert	3035/95.40	
	Test Sequencer	3035/95.90	
	LabWindows/CVI drivers	3035/95.99	
	Calibration report	3035/94.01	
	Transport case	3035/92.03	

Table O-6 Assignments of modules and software



Index

Symbols

<disabled> O-32

Numerical

2-point cell delay variation A-19
2-pt. CDVpp A-19

A

AAL type O-11, O-14, O-38
AAL type distribution O-14
Activity (channel performance) A-19
Activity scan O-11
Address O-21, A-11
Address input O-22, A-8, A-11
AFI (address type) O-24
Aging function O-13
AIS O-11
Alarm states O-9, O-15, A-18
Alarms A-19
Analyse AAL type O-13
Analyzed cells A-19
Anomaly/Defect Analyzer O-1, O-7
Anomaly/Defect Insertion O-1
Application I-9
Application Manager A-1
Associated signaling O-22
ATM address O-21
ATM Channel Explorer O-11, O-12
ATM channels A-22
ATM layer O-16, O-19, O-25, O-29, A-6
ATM Layer QoS - Looped Topology O-25, O-27
ATM Layer QoS (PVC) - Looped O-25, O-29
ATM Layer QoS (PVC) - Point-to-point O-25, O-28
ATM Layer QoS (SVC) - Called O-26, O-30
ATM Layer QoS (SVC) - Calling O-26, O-30
ATM Layer QoS (SVC) - Self Call O-26, O-31
ATM Test Control O-1, O-38, A-4, A-5, TB-10,
TB-13, TB-15
ATM Test Results O-7, A-4

B

Backward O-43
Bi-directional asym. O-40
Bi-directional sym. O-40
Bit error measurement O-1
Bit rate O-21, O-34
Burst Size O-36, O-45

Burst Tolerance O-43

C

Call address O-21
Called instrument O-25
Called party O-30
Called party address O-35
Calling instrument O-25
Calling party O-30
CBR O-34, O-40
CBR.1 O-43
CDVT peak O-43
CDVT sustained O-43
Cell Error A-18
Cell Jitter O-36, O-45
Cell Loss A-18
Cell Misins. A-18
Cell transfer delay A-19
Change Address button O-22
Channel Editor O-5, O-38, O-43, O-45
Channel Explorer A-22
Channel import O-38
CI O-34, O-41
CLP O-34, O-41
Combined values BW: ... Mbps TB-7
Configuration diagram O-3
Configure test O-26
Configuring the instrument A-5
Connected A-17
Connecting A-17
Connection configuration (topology) A-5
Connection mode I-9, O-25, A-9
Contract parameters O-39

D

Database O-38
DBR O-34, O-40
DCC (address type) O-24
Default header O-41
Defect Seconds A-21
Defect seconds A-19
Delay Related Parameters A-19
disabled O-34
Disabled pseudo topology O-18
Disconnected A-17
Displaying results A-15

**E**

E.191 (address type) O-24
Edit signal structure A-7
Emulate topology O-17, O-21, A-6
End-to-end measurement A-4
Error insertion O-6, A-14
Error management O-15
Error related parameters A-18
ESI (address type) O-24

F

F4 (OAM flow) O-15
F5 (OAM flow) O-15
Forward O-43
Frame structure O-21

G

General (Channel Editor) O-40
geschaltete Verbindung (SVC) TB-7
GFC O-34, O-41

H

Header O-34
Header/Address O-39, O-41
HEC Error Counts A-21
HO-DSP (address type) O-24

I

ICD (address type) O-24
IDI (address type) O-24
Idle cells O-20, A-6
Instrument configuration O-4, O-16, O-19, A-5
Instrument status O-3
Interface O-20
Intermediate A-18
ISDN O-23
ITU-T A-7
ITU-T O.191 O-9, A-18

L

Link (Receiver status) A-20
Log file O-10, O-30, A-16
Looped topology O-18, O-25
LPAC A-19

M

Mapping O-21
Max. CTD A-19
Mean Cell Rate O-36, O-45
Mean CTD A-19
Measurement applications A-1
Min. CTD A-19
Multiplexer O-37

N

Native E.164 O-23
NCS A-19
Network specific (address number) O-23
NNI O-13, O-20
nrt-VBR O-34
NSAP (address type) O-23, O-24

O

Overhead Generator O-21
Own instrument address O-35

P

Payload scrambler O-20, A-6
Peak Cell Rate O-36, O-43, O-45
Permanent Virtual Circuit (PVC) O-16
Permanent virtual connection O-21, O-40
Physical interface O-21
Physical layer O-1, O-7, O-11, O-16, O-25, O-29,
A-6
Point-to-point connection O-25
Port configuration O-3, O-4, O-16, O-17
Protocol O-22
Protocol layer O-4, O-16
PVCs O-25, O-38

Q

Q.2931 O-22
Quality of Service O-7, O-25, A-13, A-15, A-18
Quality of Service class O-44
Quality of Service Measurements A-3

R

RDI O-11
Receiver Status O-7, O-9, A-15, A-20
rt-VBR O-34
Rx O-34

**S**

SBR O-34, O-40
 Scan activity O-14
 Scan start/stop O-13
 Scan type O-11, O-12
 SECB A-18
 SEL (address type) O-24
 Select channel O-33, A-10
 Selection (virtual channel type) O-33
 Self call O-25, O-31
 Set default O-36
 Set maximum O-36
 Shape to contract O-36
 Signal Structure O-1, O-7, O-11, O-16, O-21, A-1,
 A-4, A-6
 Signaling O-10, O-16, A-7
 Signaling (specifications) S-12
 Signaling Analysis O-7, O-10, A-15
 Signaling channel O-22
 Signaling emulation I-9, O-4, O-16, O-17, O-21, A-6
 Signaling events A-17
 Signaling protocol O-21
 Sort criterion O-12
 Source parameters O-6, O-36, O-39, O-45, A-11
 Starting the measurement A-2
 Stopping a measurement A-2
 Stuffing A-6
 Subaddress O-24
 Sustainable Cell Rate O-43
 SVCs O-25, O-38
 Switched Virtual Circuit (SVC) O-10, O-16
 Switched virtual connection O-40
 Switched Virtual Connection (SVC) O-31
 Switched virtual connections O-21

T

Test channel O-32
 Test Online Control O-6, A-13
 Test Setup O-4, O-26, TB-8
 Test Setup - ATM Layer QoS O-32
 Test type I-9, O-2, O-4, O-25, A-9
 Topology I-10, O-4, A-3
 Traffic button A-2
 Traffic contract O-38, O-39, O-43
 Traffic Enable A-12
 Traffic generator O-36
 Traffic shaper O-36, A-13
 Traffic source O-39, O-45
 Trouble scan O-11
 Tx O-34
 Tx/Rx Configuration O-17, O-19

U

UBR O-34
 Unassigned cell A-6
 Unassigned cells O-20
 UNI O-13, O-20, A-6
 UNI 3.0 O-22
 UNI 3.1 O-22
 UNI/NNI O-34, O-41
 Unidirectional O-40

V

VBR - nRT O-40
 VBR - RT O-40
 VBR.1 O-43
 VC-AIS A-19
 VCI O-34, O-41, S-1, S-12
 VC-RDI A-19
 Virtual channel O-11, O-32, O-38, O-40
 Virtual instruments (VIs) A-1
 Virtual path O-40
 VP-AIS A-19
 VPI O-34, O-41, S-1, S-12
 VPI/VCI O-11, O-13, O-38
 VP-RDI A-19



Notes: